



Soft Goods Order Form

9450 W. Laraway Rd.
Frankfort, IL 60423
P: 800-843-7234
F: 888-479-1515
www.therafin.com

Client:

Account Number:

Shipping Address:

Mark For:

ATP:

PO#

Patient Dimensions

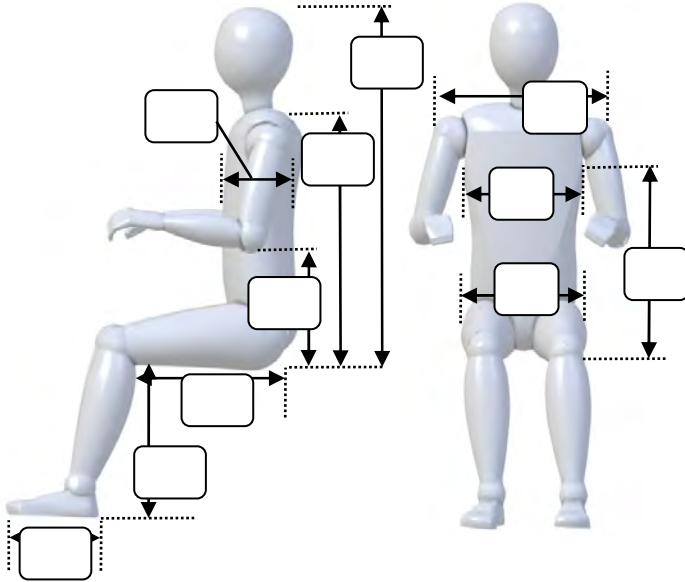

Chair Manuf.

Chair Model

Chair Width

Chair Depth

Wheelchair Dimensions

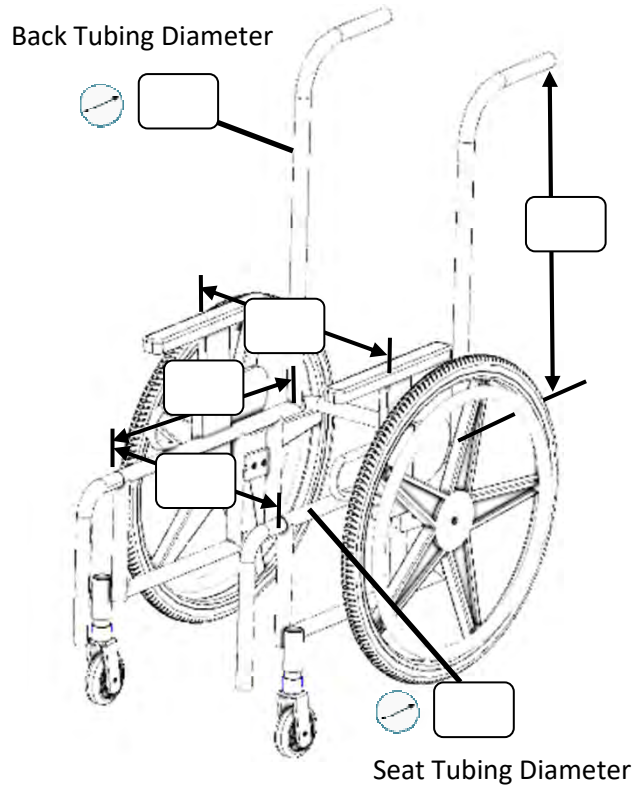

TheraFit 4 Point Hip Belt

PUSH BUTTON BUCKLE

1" Straps, 4.25L x 1.75H Pads E0978

<input type="checkbox"/>	60125 Adjustable straps, metal buckle	\$138.00
<input type="checkbox"/>	60490 Adjustable straps, security buckle	\$148.00
<input type="checkbox"/>	60135 Adjustable straps, plastic side release buckle	\$134.00
<input type="checkbox"/>	60130 Fixed straps, metal buckle	\$130.00
<input type="checkbox"/>	60494 Fixed straps, security buckle	\$141.00
<input type="checkbox"/>	60140 Fixed straps, plastic side release buckle	\$127.00

1" Straps, 5.25L x 1.75H Pads E0978

<input type="checkbox"/>	60126 Adjustable straps, metal buckle	\$138.00
<input type="checkbox"/>	60491 Adjustable straps, security buckle	\$148.00
<input type="checkbox"/>	60136 Adjustable straps, plastic side release buckle	\$134.00
<input type="checkbox"/>	60131 Fixed straps, metal buckle	\$130.00
<input type="checkbox"/>	60494 Fixed straps, security buckle	\$141.00
<input type="checkbox"/>	60495 Fixed straps, plastic side release buckle	\$141.00

1.5" Straps, 5.25L x 2.25H Pads E0978

<input type="checkbox"/>	60127 Adjustable straps, metal buckle	\$138.00
<input type="checkbox"/>	60492 Adjustable straps, security buckle	\$148.00
<input type="checkbox"/>	60137 Adjustable straps, plastic side release buckle	\$134.00
<input type="checkbox"/>	60132 Fixed straps, metal buckle	\$130.00
<input type="checkbox"/>	60496 Fixed straps, security buckle	\$141.00
<input type="checkbox"/>	60142 Fixed straps, plastic side release buckle	\$127.00

1.5" Straps, 7.25L x 2.25H Pads E0978

<input type="checkbox"/>	60128 Adjustable straps, metal buckle	\$138.00
<input type="checkbox"/>	60493 Adjustable straps, security buckle	\$148.00
<input type="checkbox"/>	60138 Adjustable straps, plastic side release buckle	\$134.00
<input type="checkbox"/>	60133 Fixed straps, metal buckle	\$130.00
<input type="checkbox"/>	60497 Fixed straps, security buckle	\$141.00
<input type="checkbox"/>	60143 Fixed straps, plastic side release buckle	\$127.00

Y-Style Pads, 1" Straps, 6" long Pads E0978

<input type="checkbox"/>	60024 Adjustable straps, metal buckle	\$169.00
<input type="checkbox"/>	60046 Adjustable straps, security buckle	\$181.00
<input type="checkbox"/>	60027 Adjustable straps, plastic side release buckle	\$164.00

Y-Style Pads, 1.5" Straps, 9" long Pads E0978

<input type="checkbox"/>	60025 Adjustable straps, metal buckle	\$169.00
<input type="checkbox"/>	60047 Adjustable straps, security buckle	\$181.00
<input type="checkbox"/>	60028 Adjustable straps, plastic side release buckle	\$164.00

Y-Style Pads, 2" Straps, 11" long Pads E0978

<input type="checkbox"/>	60026 Adjustable straps, metal buckle	\$169.00
<input type="checkbox"/>	60048 Adjustable straps, security buckle	\$181.00
<input type="checkbox"/>	60029 Adjustable straps, plastic side release buckle	\$164.00



TheraFit Single Pull Hip Belt

PUSH BUTTON BUCKLE

Single Pull 1" Straps, 4.25L x 1.75H Pads E0978

<input type="checkbox"/>	61001 Belt w/Clips	\$ 82.00
<input type="checkbox"/>	61002 Belt w/Cams	\$ 82.00
<input type="checkbox"/>	61003 Belt w/Clips AND Cams	\$ 87.00

Single Pull 1" Straps, 5.25L x 1.75H Pads E0978

<input type="checkbox"/>	61101 Belt w/Clips	\$ 82.00
<input type="checkbox"/>	61102 Belt w/Cams	\$ 82.00
<input type="checkbox"/>	61103 Belt w/Clips AND Cams	\$ 85.00

Single Pull 1" Straps, 6.25L x 1.75H Pads E0978

<input type="checkbox"/>	61201 Belt w/Clips	\$ 82.00
<input type="checkbox"/>	61202 Belt w/Cams	\$ 82.00
<input type="checkbox"/>	61203 Belt w/Clips AND Cams	\$ 85.00

Single Pull 1.5" Straps, 5.25L x 2.25H Pads E0978

<input type="checkbox"/>	62001 Belt w/Clips	\$ 91.00
<input type="checkbox"/>	62002 Belt w/Cams	\$104.00
<input type="checkbox"/>	62003 Belt w/Clips AND Cams	\$109.00

Single Pull 1.5" Straps, 7.25L x 2.25H Pads E0978

<input type="checkbox"/>	62101 Belt w/Clips	\$ 91.00
<input type="checkbox"/>	62102 Belt w/Cams	\$104.00
<input type="checkbox"/>	62103 Belt w/Clips AND Cams	\$109.00

Single Pull 1.5" Straps, 9.25L x 2.25H Pads E0978

<input type="checkbox"/>	62201 Belt w/Clips	\$ 91.00
<input type="checkbox"/>	62202 Belt w/Cams	\$104.00
<input type="checkbox"/>	62203 Belt w/Clips AND Cams	\$109.00

Single Pull 2" Straps, 9.25L x 3H Pads E0978

<input type="checkbox"/>	64001 Belt w/Clips	\$ 97.00
<input type="checkbox"/>	64002 Belt w/Cams	\$111.00
<input type="checkbox"/>	64003 Belt w/Clips AND Cams	\$115.00

Single Pull 2" Straps, 11.25L x 3H Pads E0978

<input type="checkbox"/>	64101 Belt w/Clips	\$ 97.00
<input type="checkbox"/>	64102 Belt w/Cams	\$111.00
<input type="checkbox"/>	64103 Belt w/Clips AND Cams	\$115.00

Bariatric Single Pull 2" Straps, 11.25L x 3H Pads E0978

<input type="checkbox"/>	64301 Belt w/Clips	\$108.00
<input type="checkbox"/>	64302 Belt w/Cams	\$129.00
<input type="checkbox"/>	64303 Belt w/Clips AND Cams	\$131.00

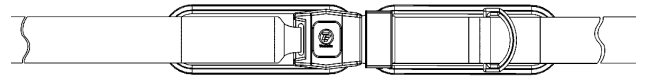

METAL CLIP



CAM LOCK
BUCKLE

TheraFit Single Pull Hip Belt

SECURITY STYLE BUCKLE

Single Pull 1" Straps, 4.25L x 1.75H Pads E0978

<input type="checkbox"/>	60411 Belt w/Clips	\$ 94.00
<input type="checkbox"/>	60412 Belt w/Cams	\$ 94.00
<input type="checkbox"/>	60413 Belt w/Clips AND Cams	\$ 96.00

Single Pull 1" Straps, 5.25L x 1.75H Pad

<input type="checkbox"/>	60421 Belt w/Clips	\$ 94.00
<input type="checkbox"/>	60422 Belt w/Cams	\$ 94.00
<input type="checkbox"/>	60423 Belt w/Clips AND Cams	\$ 96.00

Single Pull 1" Straps, 6.25L x 1.75H Pads E0978

<input type="checkbox"/>	60431 Belt w/Clips	\$ 94.00
<input type="checkbox"/>	60432 Belt w/Cams	\$ 94.00
<input type="checkbox"/>	60433 Belt w/Clips AND Cams	\$ 96.00

Single Pull 1.5" Straps, 5.25L x 2.25H Pads

<input type="checkbox"/>	60441 Belt w/Clips	\$102.00
<input type="checkbox"/>	60442 Belt w/Cams	\$115.00
<input type="checkbox"/>	60443 Belt w/Clips AND Cams	\$119.00

Single Pull 1.5" Straps, 7.25L x 2.25H Pads E0978

<input type="checkbox"/>	60451 Belt w/Clips	\$102.00
<input type="checkbox"/>	60452 Belt w/Cams	\$115.00
<input type="checkbox"/>	60453 Belt w/Clips AND Cams	\$119.00

Single Pull 1.5" Straps, 9.25L x 2.25H Pads E0978

<input type="checkbox"/>	60461 Belt w/Clips	\$102.00
<input type="checkbox"/>	60462 Belt w/Cams	\$115.00
<input type="checkbox"/>	60463 Belt w/Clips AND Cams	\$119.00

Single Pull 2" Straps, 9.25L x 3H Pads E0978

<input type="checkbox"/>	60471 Belt w/Clips	\$109.00
<input type="checkbox"/>	60472 Belt w/Cams	\$121.00
<input type="checkbox"/>	60473 Belt w/Clips AND Cams	\$126.00

Single Pull 2" Straps, 11.25L x 3H Pads E0978

<input type="checkbox"/>	60481 Belt w/Clips	\$109.00
<input type="checkbox"/>	60482 Belt w/Cams	\$121.00
<input type="checkbox"/>	60483 Belt w/Clips AND Cams	\$126.00

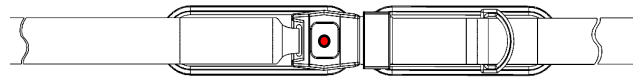

METAL CLIP



CAM LOCK BUCKLE

TheraFit Single Pull Hip Belt

SIDE RELEASE STYLE BUCKLE

Single Pull 1" Straps, 4.25L x 1.75H Pads E0978

- | | | |
|--------------------------|-----------------------------|----------|
| <input type="checkbox"/> | 65001 Belt w/Clips | \$ 76.00 |
| <input type="checkbox"/> | 65002 Belt w/Cams | \$ 76.00 |
| <input type="checkbox"/> | 65003 Belt w/Clips AND Cams | \$ 78.00 |

Single Pull 1" Straps, 5.25L x 1.75H Pads E0978

- | | | |
|--------------------------|-----------------------------|----------|
| <input type="checkbox"/> | 65101 Belt w/Clips | \$ 76.00 |
| <input type="checkbox"/> | 65102 Belt w/Cams | \$ 76.00 |
| <input type="checkbox"/> | 65103 Belt w/Clips AND Cams | \$ 78.00 |

Single Pull 1" Straps, 6.25L x 1.75H Pads E0978

- | | | |
|--------------------------|-----------------------------|----------|
| <input type="checkbox"/> | 65201 Belt w/Clips | \$ 76.00 |
| <input type="checkbox"/> | 65202 Belt w/Cams | \$ 76.00 |
| <input type="checkbox"/> | 65203 Belt w/Clips AND Cams | \$ 78.00 |

Single Pull 1.5" Straps, 5.25L x 2.25H Pads E0978

- | | | |
|--------------------------|-----------------------------|----------|
| <input type="checkbox"/> | 65301 Belt w/Clips | \$ 84.00 |
| <input type="checkbox"/> | 65302 Belt w/Cams | \$ 97.00 |
| <input type="checkbox"/> | 65303 Belt w/Clips AND Cams | \$101.00 |

Single Pull 1.5" Straps, 7.25L x 2.25H Pads E0978

- | | | |
|--------------------------|-----------------------------|----------|
| <input type="checkbox"/> | 65401 Belt w/Clips | \$ 84.00 |
| <input type="checkbox"/> | 65402 Belt w/Cams | \$ 97.00 |
| <input type="checkbox"/> | 65403 Belt w/Clips AND Cams | \$101.00 |

Single Pull 1.5" Straps, 9.25L x 2.25H Pads E0978

- | | | |
|--------------------------|-----------------------------|----------|
| <input type="checkbox"/> | 65501 Belt w/Clips | \$ 84.00 |
| <input type="checkbox"/> | 65502 Belt w/Cams | \$ 97.00 |
| <input type="checkbox"/> | 65503 Belt w/Clips AND Cams | \$101.00 |

Single Pull 2" Straps, 9.25L x 3H Pads E0978

- | | | |
|--------------------------|-----------------------------|----------|
| <input type="checkbox"/> | 65601 Belt w/Clips | \$ 90.00 |
| <input type="checkbox"/> | 65602 Belt w/Cams | \$103.00 |
| <input type="checkbox"/> | 65603 Belt w/Clips AND Cams | \$108.00 |

Single Pull 2" Straps, 11.25L x 3H Pads E0978

- | | | |
|--------------------------|-----------------------------|----------|
| <input type="checkbox"/> | 65701 Belt w/Clips | \$ 90.00 |
| <input type="checkbox"/> | 65702 Belt w/Cams | \$103.00 |
| <input type="checkbox"/> | 65703 Belt w/Clips AND Cams | \$108.00 |

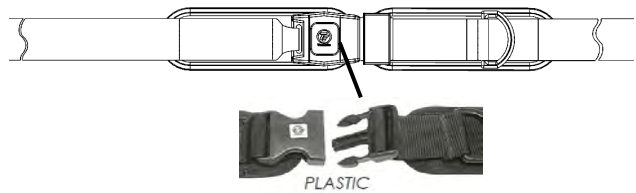

METAL CLIP



CAM LOCK BUCKLE

TheraFit Single Pull Unpadde

PUSH BUTTON BUCKLE

Single Pull 1" Straps, Unpadded E0978

- | | | |
|--------------------------|--------------------|----------|
| <input type="checkbox"/> | 33120 Belt w/Clips | \$ 48.00 |
|--------------------------|--------------------|----------|

Single Pull 1.5" Straps, Unpadded E0978

- | | | |
|--------------------------|-----------------------------|----------|
| <input type="checkbox"/> | 33130 Belt w/Clips AND Cams | \$ 48.00 |
|--------------------------|-----------------------------|----------|

Single Pull 2" Straps, Unpadded E0978

- | | | |
|--------------------------|----------------------------------------|----------|
| <input type="checkbox"/> | 33140 Belt w/Clips AND Cams | \$ 48.00 |
| <input type="checkbox"/> | 33148 Extra Long 80" Long Belt w/Clips | \$ 54.00 |

SECURITY STYLE BUCKLE

Single Pull 1" Straps, Unpadded E0978

- | | | |
|--------------------------|--------------------|----------|
| <input type="checkbox"/> | 33126 Belt w/Clips | \$ 62.00 |
|--------------------------|--------------------|----------|

Single Pull 1.5" Straps, Unpadded E0978

- | | | |
|--------------------------|-----------------------------|----------|
| <input type="checkbox"/> | 60310 Belt w/Clips AND Cams | \$ 62.00 |
|--------------------------|-----------------------------|----------|

Single Pull 2" Straps, Unpadded E0978

- | | | |
|--------------------------|-----------------------------|----------|
| <input type="checkbox"/> | 33146 Belt w/Clips AND Cams | \$ 62.00 |
|--------------------------|-----------------------------|----------|

SIDE RELEASE STYLE BUCKLE

Single Pull 1" Straps, Unpadded E0978

- | | | |
|--------------------------|--------------------|----------|
| <input type="checkbox"/> | 33127 Belt w/Clips | \$ 45.00 |
|--------------------------|--------------------|----------|

Single Pull 1.5" Straps, Unpadded E0978

- | | | |
|--------------------------|-----------------------------|----------|
| <input type="checkbox"/> | 33136 Belt w/Clips AND Cams | \$ 45.00 |
|--------------------------|-----------------------------|----------|

Single Pull 2" Straps, Unpadded E0978

- | | | |
|--------------------------|-----------------------------|----------|
| <input type="checkbox"/> | 33147 Belt w/Clips AND Cams | \$ 45.00 |
|--------------------------|-----------------------------|----------|

METAL FLAP (AIRPLANE) STYLE BUCKLE

Single Pull 2" Straps, Unpadded E0978

- | | | |
|--------------------------|--------------------|----------|
| <input type="checkbox"/> | 33149 Belt w/Clips | \$ 81.00 |
|--------------------------|--------------------|----------|

PUSH BUTTON BUCKLE

Push Button (Travis Logo) Single Pull 1.5" Straps, Unpadded E0978

- | | | |
|--------------------------|--------------------|----------|
| <input type="checkbox"/> | 60129 Belt w/Clips | \$ 48.00 |
|--------------------------|--------------------|----------|

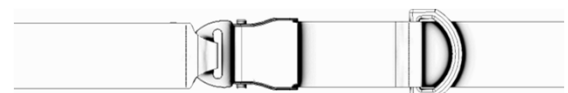
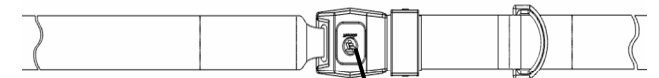
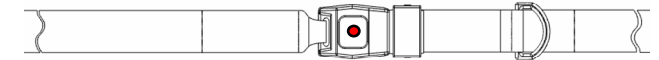
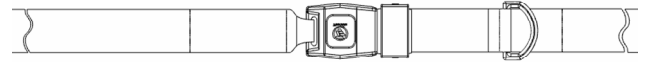

TheraFit Slip on Pads

Slip on Pads for 1" Strap Width K0108

- 33178 Slip on Hip Belt Pad 4.25W x 1.75 H, Pair \$ 54.00
- 33179 Slip on Hip Belt Pad 5.25W x 1.75 H, Pair \$ 54.00
- 33180 Slip on Hip Belt Pad 6.25W x 1.75 H, Pair \$ 54.00

Slip on Pads for 1.5" Strap Width K0108

- 33181 Slip on Hip Belt Pad 5.25W x 2.25 H, Pair \$ 54.00
- 33182 Slip on Hip Belt Pad 7.25W x 2.25 H, Pair \$ 54.00
- 33183 Slip on Hip Belt Pad 9.25W x 2.5 H, Pair \$ 54.00
- 33186 Slip on Hip Belt Pad 10.25W x 2.5 H, Pair \$ 54.00

Slip on Pads for 2" Strap Width K0108

- 33184 Slip on Hip Belt Pad 9.25W x 3 H, Pair \$ 54.00
- 33187 Slip on Hip Belt Pad 10.25W x 3 H, Pair \$ 54.00
- 33185 Slip on Hip Belt Pad 11.25W x 3 H, Pair \$ 54.00



TheraFit Rear Pull Hip Belt

PUSH BUTTON BUCKLE

Single Pull 1" Straps, 6.25L x 1.75H Pads E0978

- 60161 Belt w/Clips \$ 94.00
- 60162 Belt w/Cams \$ 94.00
- 60163 Belt w/Clips AND Cams \$ 96.00

Single Pull 1.5" Straps, 7.25L x 2.25H Pads E0978

- 60171 Belt w/Clips \$102.00
- 60172 Belt w/Cams \$115.00
- 60173 Belt w/Clips AND Cams \$119.00

Single Pull 1.5" Straps, 9.25L x 2.5H Pads E0978

- 60181 Belt w/Clips \$102.00
- 60182 Belt w/Cams \$115.00
- 60183 Belt w/Clips AND Cams \$119.00

SECURITY STYLE BUCKLE

Single Pull 1" Straps, 6.25L x 1.75H Pads E0978

- 60311 Belt w/Clips \$104.00
- 60312 Belt w/Cams \$104.00
- 60313 Belt w/Clips AND Cams \$106.00

Single Pull 1.5" Straps, 7.25L x 2.25H Pads E0978

- 60321 Belt w/Clips \$113.00
- 60322 Belt w/Cams \$126.00
- 60323 Belt w/Clips AND Cams \$130.00

Single Pull 1.5" Straps, 9.25L x 2.5H Pads E0978

- 60331 Belt w/Clips \$113.00
- 60332 Belt w/Cams \$126.00
- 60333 Belt w/Clips AND Cams \$130.00

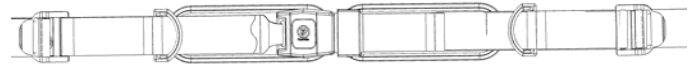

METAL CLIP



CAM LOCK BUCKLE



METAL CLIP



CAM LOCK BUCKLE

TheraFit Center Pull Hip Belt

SIDE RELEASE STYLE BUCKLE

Center Pull 1" Straps, 4.25L x 1.75H Pads E0978

<input type="checkbox"/>	60211 Belt w/Clips	\$ 77.00
<input type="checkbox"/>	60212 Belt w/Cams	\$ 77.00
<input type="checkbox"/>	60213 Belt w/Clips AND Cams	\$ 80.00

Center Pull 1" Straps, 5.25L x 1.75H Pads E0978

<input type="checkbox"/>	60221 Belt w/Clips	\$ 77.00
<input type="checkbox"/>	60222 Belt w/Cams	\$ 77.00
<input type="checkbox"/>	60223 Belt w/Clips AND Cams	\$ 80.00

Center Pull 1.5" Straps, 5.25L x 2.25H Pads E0978

<input type="checkbox"/>	60231 Belt w/Clips	\$ 85.00
<input type="checkbox"/>	60232 Belt w/Cams	\$ 98.00
<input type="checkbox"/>	60233 Belt w/Clips AND Cams	\$102.00

Center Pull 1.5" Straps, 7.25L x 2.25H Pads E0978

<input type="checkbox"/>	60241 Belt w/Clips	\$ 85.00
<input type="checkbox"/>	60242 Belt w/Cams	\$ 98.00
<input type="checkbox"/>	60243 Belt w/Clips AND Cams	\$102.00



Hip Belt Accessories

Hip Belt Extender Straps K0108

<input type="checkbox"/>	60144 Belt Extender Straps, 1" Pair	\$ 41.00
<input type="checkbox"/>	60145 Belt Extender Straps, 1.5" Pair	\$ 41.00
<input type="checkbox"/>	60146 Belt Extender Straps, 2" Pair	\$ 41.00

BELT EXTENDER STRAPS, EACH 24" LONG

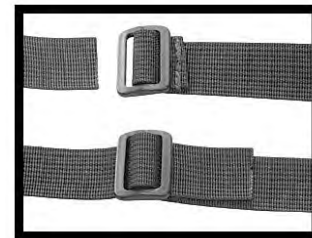

Hinged Collar K0108

	50410 Collar, Hinged - 7/8", 1" & 1-1/8" Diameter	\$ 22.00
<input type="checkbox"/>	_____ (Insert quantity)	

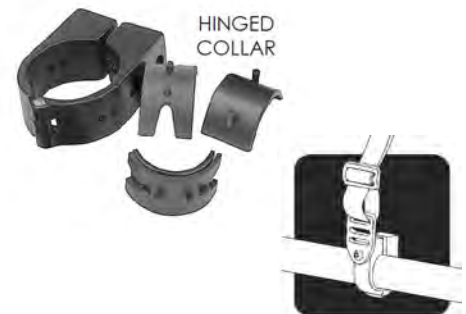

Seat Harness

STATIC SEAT HARNESS

Static Front Pull

<input type="checkbox"/>	50726 Small	\$192.00
<input type="checkbox"/>	50727 Medium	\$192.00
<input type="checkbox"/>	50728 Large	\$192.00

Static Rear Pull

<input type="checkbox"/>	50729 Small	\$192.00
<input type="checkbox"/>	50730 Medium	\$192.00
<input type="checkbox"/>	50731 Large	\$192.00

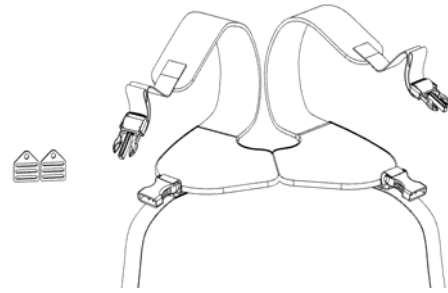

LEGACY (STRETCH) SEAT HARNESS

Stretch Harness

<input type="checkbox"/>	30516 Small	\$186.00
<input type="checkbox"/>	30517 Medium	\$186.00
<input type="checkbox"/>	30518 Large	\$186.00

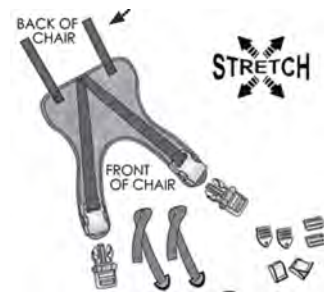

TheraFit Shoulder Harness

Shoulder Harness with Clips E0960

- 61301 Shoulder Harness, TheraFit, X-Small w/ Clip \$ 156
- 61401 Shoulder Harness, TheraFit, Small w/ Clips \$ 151
- 61501 Shoulder Harness, TheraFit, Medium w/ Clip \$ 157
- 61701 Shoulder Harness, TheraFit, Large w/ Clips \$ 164
- 61801 Shoulder Harness, TheraFit, X-Large w/ Clip \$ 171

Shoulder Harness with Camlocks E0960

- 61302 Shoulder Harness, TheraFit, X-Small w/ Can \$ 156
- 61402 Shoulder Harness, TheraFit, Small w/ Camlo \$ 151
- 61502 Shoulder Harness, TheraFit, Medium w/ Can \$ 157
- 61702 Shoulder Harness, TheraFit, Large w/ Camlo \$ 164
- 61802 Shoulder Harness, TheraFit, X-Large w/ Can \$ 171

Shoulder Harness with Clips and Camlocks E0960

- 61303 Shoulder Harness, TheraFit, X-Small w/ Clip \$ 156
- 61403 Shoulder Harness, TheraFit, Small w/ Clips & \$ 151
- 61503 Shoulder Harness, TheraFit, Medium w/ Clip \$ 157
- 61703 Shoulder Harness, TheraFit, Large w/ Clips & \$ 164
- 61803 Shoulder Harness, TheraFit, X-Large w/ Clip \$ 171

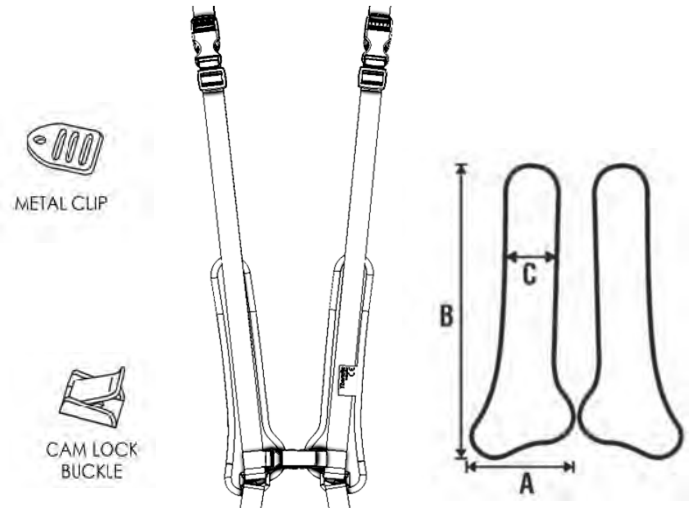

Harness Dimensions (inches)	A	B	C
X-SMALL	2.7	8.6	1.4
SMALL	3.0	12.0	1.8
MEDIUM	3.4	13.4	2.0
LARGE	4.0	16.1	2.3
X-LARGE	4.5	18.2	2.6



Stretch TheraFit Vest

Full Shape with Comfort Fit Straps E0960

- 30589 Vest, Full, Small \$ 161
- 30590 Vest, Full, Medium \$ 161
- 30591 Vest, Full, Large \$ 161
- 30592 Vest, Full, X-Large \$ 161
- 30593 Vest, Full, 2X-Large \$ 169

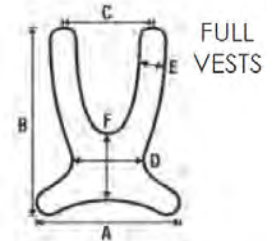

Trim Shape with Comfort Fit Straps E0960

- 30601 Vest, Trim, Early Intervention \$ 163
- 30618 Vest, Trim, Small \$ 163
- 30619 Vest, Trim, Medium \$ 163
- 30620 Vest, Trim, Large \$ 163
- 30621 Vest, Trim, X-Large \$ 169
- 30622 Vest, Trim, 2X-Large \$ 169



Vest Dimensions (inches)	A	B	C	D	E	F
Full SMALL	9.5	12.5	5.5	5	2	5
Full MEDIUM	11.25	15	7	5.75	2	5.5
Full LARGE	13.5	18	8.5	7	2.5	6.5
Full X-LARGE	15.75	21	10	8	3	7.5
Full 2X-LARGE	18	24	11	9.25	3.5	8.5

Full Shape with Extended Straps Straps E0960

- 30594 Vest, Full, Small \$ 161
- 30595 Vest, Full, Medium \$ 161
- 30596 Vest, Full, Large \$ 161
- 30597 Vest, Full, X-Large \$ 169
- 30598 Vest, Full, 2X-Large \$ 169

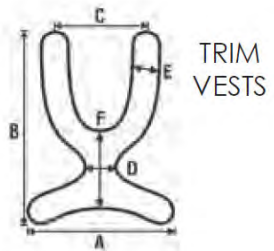

Trim Shape with Comfort Fit Straps E0960

- 30603 Vest, Trim, Early Intervention \$ 163
- 30604 Vest, Trim, Small \$ 163
- 30624 Vest, Trim, Medium \$ 163
- 30625 Vest, Trim, Large \$ 163
- 30626 Vest, Trim, X-Large \$ 169
- 30627 Vest, Trim, 2X-Large \$ 169



Vest Dimensions (inches)	A	B	C	D	E	F
Trim EARLY INTERVENTION	7.25	10.5	6.25	1	1.5	4
Trim SMALL	9.5	12.5	6	2	2	5.5
Trim MEDIUM	11.25	15	7	2.5	2	6
Trim LARGE	13.5	18	8.5	3	2.5	7.25
Trim X-LARGE	15.75	21	10	3.5	3	8.5
Trim 2X-LARGE	18	24	11	4.25	3.5	9.5

Non-Stretch Legacy Vest

Full Shape with No-Sew Buckles (Comfort Fit) E0960

<input type="checkbox"/>	30479 Static,w/ No-Sew Buckles, Full, Small	\$ 166
<input type="checkbox"/>	30480 Static w/ No-Sew Buckles, Full, Medium	\$ 166
<input type="checkbox"/>	30481 Static w/ No-Sew Buckles, Male, Large	\$ 166
<input type="checkbox"/>	30507 Static w/ No-Sew Buckles, Male, X-Large	\$ 166

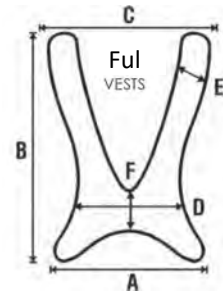

Trim Shape with No-Sew Buckles (Comfort Fit) E09

<input type="checkbox"/>	30482 Static w/ No-Sew Buckles, Trim, Small	\$ 166
<input type="checkbox"/>	30483 Static w/ No-Sew Buckles, Trim, Medium	\$ 166
<input type="checkbox"/>	30484 Static w/ No-Sew Buckles, Trim, Large	\$ 166

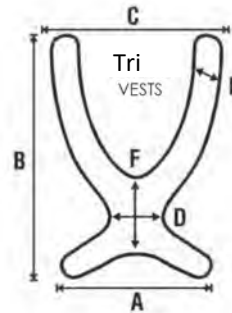

Full Shape with Extended Straps E0960

<input type="checkbox"/>	51044 Static w/ Extended Straps, Full, X-Small	\$ 166
<input type="checkbox"/>	51045 Static w/ Extended Straps, Full, Small	\$ 166
<input type="checkbox"/>	51046 Static w/ Extended Straps, Full, Medium	\$ 166
<input type="checkbox"/>	51047 Static w/ Extended Straps, Full, Large	\$ 166
<input type="checkbox"/>	51048 Static w/ Extended Straps, Full, X-Large	\$ 166



Stretch & Non-Stretch Vests						
Vest Dimensions (inches)	A	B	C	D	E	F
Male X-SMALL	5.5	7.5	7.5	4.75	1.5	3.5
Male SMALL	7	12	8	5.5	1.75	2.75
Male MEDIUM	8.25	14	9.75	6.5	2.25	3
Male LARGE	8.75	17.25	12.5	6.75	2.5	5.25
Male X-LARGE	11	21.75	13	7.5	3	7
Female SMALL	7	11	8	2	2	5.25
Female MEDIUM	8	12.5	8	2	2	5.75
Female LARGE	8	16	10	2	2.25	7.5

Trim Shape with Extended Straps E0960

<input type="checkbox"/>	51049 Static w/ Extended Straps, Trim, Small	\$ 166
<input type="checkbox"/>	51050 Static w/ Extended Straps, Trim, Medium	\$ 166
<input type="checkbox"/>	51051 Static w/ Extended Straps, Trim, Large	\$ 166

TheraFit Zipper Vest

Full Shape, Structured (Non-Stretch) E0960

<input type="checkbox"/>	30771 Structured, Zip-Up, Full, Small	\$ 177
<input type="checkbox"/>	30772 Structured, Zip-Up, Full, Medium	\$ 177
<input type="checkbox"/>	30773 Structured, Zip-Up, Full, Large	\$ 177

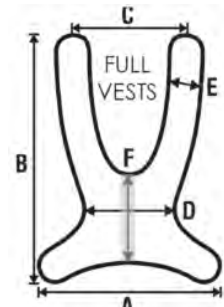
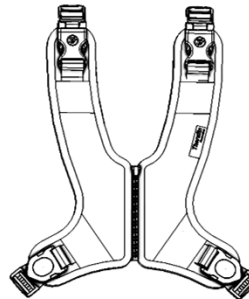

Full Shape, Stretch (Non-Stretch) E0960

<input type="checkbox"/>	30777 Stretch, Zip-Up, Full, Small	\$ 177
<input type="checkbox"/>	30778 Stretch, Zip-Up, Full, Medium	\$ 177
<input type="checkbox"/>	30779 Stretch Zip-Up, Full, Large	\$ 177

Vest Dimensions (Inches)	A	B	C	D	E	F
Full SMALL	10.5	14	6.5	6	2	5.25
Full MEDIUM	12	16.25	7.5	6.5	2	6.5
Full LARGE	15.5	18.5	9.25	7.5	2.5	6.75

Trim Shape, Structured (Non-Stretch) E0960

<input type="checkbox"/>	30774 Structured, Zip-Up, Trim, Small	\$ 177
<input type="checkbox"/>	30775 Structured, Zip-Up, Trim, Medium	\$ 177
<input type="checkbox"/>	30776 Structured, Zip-Up, Trim, Large	\$ 177

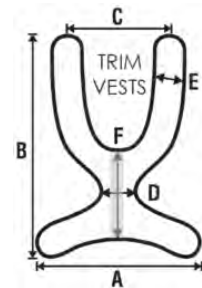
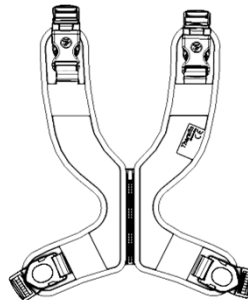

Trim Shape, Stretch (Non-Stretch) E0960

<input type="checkbox"/>	30780 Stretch, Zip-Up, Trim, Small	\$ 177
<input type="checkbox"/>	30781 Stretch Zip-Up, Trim, Medium	\$ 177
<input type="checkbox"/>	30782 Stretch, Zip-Up, Trim, Large	\$ 177

Vest Dimensions (Inches)	A	B	C	D	E	F
Trim SMALL	10.5	14	6.25	3.5	2	5.25
Trim MEDIUM	12	16.25	7.25	3.5	2	6.5
Trim LARGE	15.5	18.5	9	3.75	2.5	6.75

TheraFit Y Harness

Y Harness E0960

<input type="checkbox"/>	30683 Small	\$ 181
<input type="checkbox"/>	30684 Medium	\$ 188
<input type="checkbox"/>	30685 Large	\$ 196

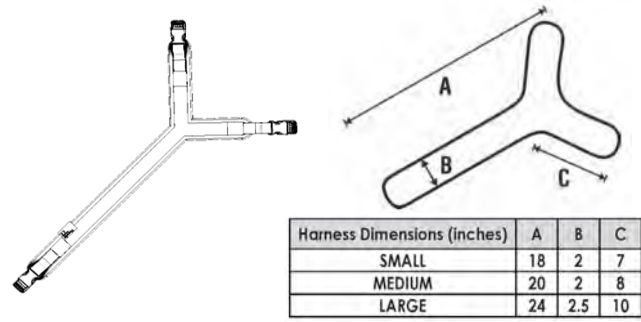

TheraFit X Harness

X Harness E0960

<input type="checkbox"/>	30519 Small	\$ 175
<input type="checkbox"/>	30520 Medium	\$ 175
<input type="checkbox"/>	30521 Large	\$ 187

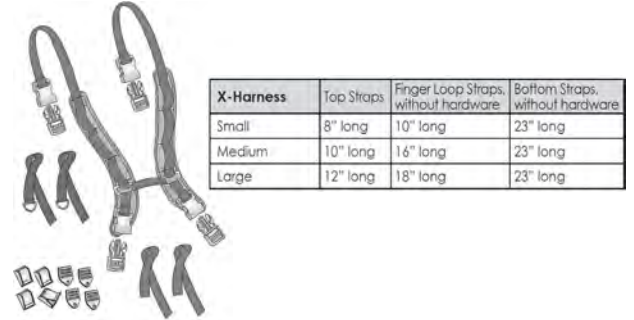

TheraFit Chest Straps

2 Buckles w/Adj. Straps (Stretch) E0960

<input type="checkbox"/>	60110 Dynamic w/ Dual D-Ring Adj, Small	\$ 105
<input type="checkbox"/>	60111 Dynamic w/ Dual D-Ring Adj, Medium	\$ 105
<input type="checkbox"/>	60112 Dynamic w/ Dual D-Ring Adj, Large	\$ 105



Size	Pad Size
Small	3x16
Medium	4x20
Large	4x24

1 Buckles w/Adj. Strap (Stretch) E0960

<input type="checkbox"/>	60113 Dynamic w/ Single D-Ring Adj, Small	\$ 134
<input type="checkbox"/>	60114 Dynamic w/ Single D-Ring Adj, Medium	\$ 134
<input type="checkbox"/>	60115 Dynamic w/ Single D-Ring Adj, Large	\$ 134
<input type="checkbox"/>	60123 Dynamic w/ Single D-Ring Adj, X-Large	\$ 156
<input type="checkbox"/>	60124 Dynamic w/ Single D-Ring Adj, 2X-Large	\$ 167



Size	Pad Size
Small	3x16
Medium	4x20
Large	4x24
X-Large	6x28
2X-Large	8x32

One-Piece w/2 Sewn Straps (Stretch) E0960

<input type="checkbox"/>	60116 Dynamic w/ Fixed Straps, Small	\$ 97
<input type="checkbox"/>	60117 Dynamic w/ Fixed Straps, Medium	\$ 97
<input type="checkbox"/>	60118 Dynamic w/ Fixed Straps, Large	\$ 97



Size	Pad Size
Small	3x16
Medium	4x20
Large	4x24

Non-Stretch

<input type="checkbox"/>	60147 Static w/ Fixed Straps, Small	\$ 97
<input type="checkbox"/>	60148 Static w/ Fixed Straps, Medium	\$ 97
<input type="checkbox"/>	60149 Static w/ Fixed Straps, Large	\$ 97

Two-Piece w/2 Sewn Straps (Stretch) E0960

<input type="checkbox"/>	60119 Dynamic w/ Hook-N-Loop Adj, Small	\$ 134
<input type="checkbox"/>	60120 Dynamic w/ Hook-N-Loop Adj, Medium	\$ 134
<input type="checkbox"/>	60121 Dynamic w/ Hook-N-Loop Adj, Large	\$ 134



Non-Stretch

<input type="checkbox"/>	60150 Static, 2-Piece w/ Hook-N-Loop Adj, Small	\$ 134
<input type="checkbox"/>	60151 Static, 2-Piece w/ Hook-N-Loop Adj, Medium	\$ 134
<input type="checkbox"/>	60152 Static, 2-Piece w/ Hook-N-Loop Adj, Large	\$ 134

Size	Pad Size
Small	3x10 (each piece)
Medium	4x14 (each piece)
Large	4x18 (each piece)

Two-Piece w/ 2 Sewn Straps, Safety Strap (Non-Stretch) E0960

- 60153 Static, 2-Piece w/ H&L Adj, 1" Safety Strap, \$ 134
- 60154 Static, 2-Piece w/ H&L Adj, 1" Safety Strap, \$ 134
- 60155 Static, 2-Piece w/ H&L Adj, 1" Safety Strap, \$ 134

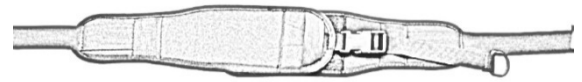

Size	Pad Size
Small	3x10 (each piece)
Medium	4x14 (each piece)
Large	4x18 (each piece)

1 Rear Buckle w/ Adj. Strap, 1 Sewn Str:

- 60157 Static w/ Single D-Ring Rear Adj, Small \$ 97
- 60158 Static w/ Single D-Ring Rear Adj, Medium \$ 97
- 60159 Static w/ Single D-Ring Rear Adj, Large \$ 97



Size	Pad Size
Small	3x16
Medium	4x20
Large	4x24

Universal Positioning Strap

Positioning Strap, Universal, Stretch E0960

- 34434 Small, 3W x 56L \$ 65
- 34435 Medium, 4.5W x 56L \$ 70
- 34436 Large, 6W x 56L \$ 75

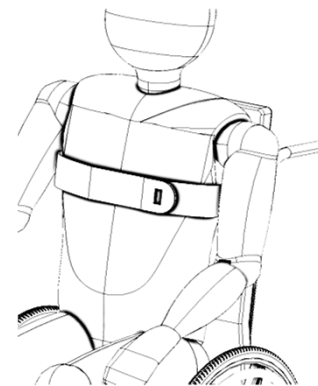

Strap Guides

Strap Positioning Guides, Pair - K0108

- 51030 Vest Strap Positioning Guides, Pair \$ 34

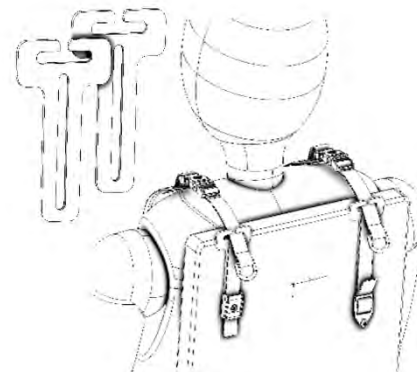

Foot Supports

Molded Shoe Holder with Padded Straps Pair K0108

<input type="checkbox"/>	30233	Molded w/ Padded Straps, Small, Pair	\$171.00
<input type="checkbox"/>	30234	Molded w/ Padded Straps, Medium, Pair	\$171.00
<input type="checkbox"/>	30235	Molded w/ Padded Straps, Large, Pair	\$171.00
<input type="checkbox"/>	30236	Molded w/ Padded Straps, X-Large, Pair	\$171.00

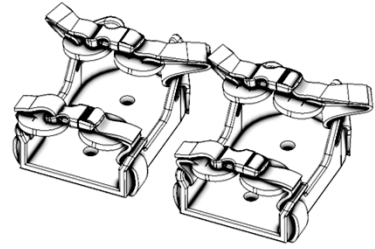

Molded Shoe Holder with Unpadded Straps Pair K0108

<input type="checkbox"/>	30293	Molded w/ Plain Straps, Small, Pair	\$155.00
<input type="checkbox"/>	30303	Molded w/ Plain Straps, Medium, Pair	\$155.00
<input type="checkbox"/>	30309	Molded w/ Plain Straps, Large, Pair	\$155.00
<input type="checkbox"/>	30316	Molded w/ Plain Straps, X-Large, Pair	\$155.00

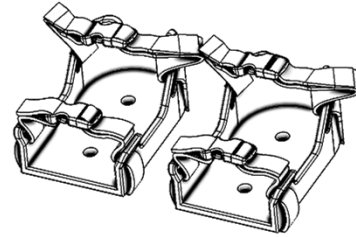

Footsure Ankle Supports with Buckle Pair K0108

<input type="checkbox"/>	60250	Buckle, X-Small, Pair	\$180.00
<input type="checkbox"/>	60251	Buckle, Small, Pair	\$180.00
<input type="checkbox"/>	60252	Buckle, Medium, Pair	\$180.00
<input type="checkbox"/>	60253	Buckle, Large, Pair	\$180.00
<input type="checkbox"/>	60254	Buckle, X-Large, Pair	\$180.00



Footsure Ankle Supports with Hook and Loop Pair K0108

<input type="checkbox"/>	60255	Hook & Loop, X-Small, Pair	\$180.00
<input type="checkbox"/>	60256	Hook & Loop, Small, Pair	\$180.00
<input type="checkbox"/>	60257	Hook & Loop, Medium, Pair	\$180.00
<input type="checkbox"/>	60258	Hook & Loop, Large, Pair	\$180.00
<input type="checkbox"/>	60259	Hook & Loop, X-Large, Pair	\$180.00



Flexsure Feet Foot Supports with Buckles Pair K0108

<input type="checkbox"/>	31765	Hook-N-Loop Closure, Small, Pair	\$321.00
<input type="checkbox"/>	31766	Hook-N-Loop Closure, Medium, Pair	\$321.00
<input type="checkbox"/>	31767	Hook-N-Loop Closure, Large, Pair	\$321.00
<input type="checkbox"/>	31768	Hook-N-Loop Closure, X-Large, Pair	\$321.00



Flexsure Feet Foot Supports with Hook and Loop Pair K0108

<input type="checkbox"/>	31772	Buckle Closure, Medium, Pair	\$321.00
<input type="checkbox"/>	31773	Buckle Closure, Large, Pair	\$321.00
<input type="checkbox"/>	31774	Buckle Closure, X-Large, Pair	\$321.00



Flexsure Padded Inserts Pair K0108

<input type="checkbox"/>	31761	Padded Inserts, Small, Pair	\$ 90.00
<input type="checkbox"/>	31762	Padded Inserts, Medium, Pair	\$ 90.00
<input type="checkbox"/>	31763	Padded Inserts, Large, Pair	\$ 90.00
<input type="checkbox"/>	31764	Padded Inserts, X-Large, Pair	\$ 90.00

Shoe Sandals with Toe Strap Pair K0108

<input type="checkbox"/>	30649	Shoe Sandals, X-Small, Pair	\$278.00
<input type="checkbox"/>	30650	Shoe Sandals, Small, Pair	\$278.00
<input type="checkbox"/>	30651	Shoe Sandals, Medium, Pair	\$278.00
<input type="checkbox"/>	30652	Shoe Sandals, Large, Pair	\$278.00

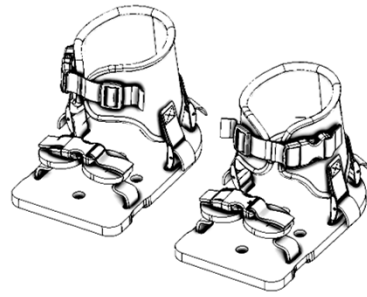

Shoe Sandals with No Toe Strap Pair E0952

<input type="checkbox"/>	30695	Shoe Sandals, No Toe Strap, X-Small, Pair	\$280.00
<input type="checkbox"/>	30696	Shoe Sandals, No Toe Strap, Small, Pair	\$280.00
<input type="checkbox"/>	30697	Shoe Sandals, No Toe Strap, Medium, Pair	\$280.00
<input type="checkbox"/>	30698	Shoe Sandals, No Toe Strap, Large, Pair	\$280.00

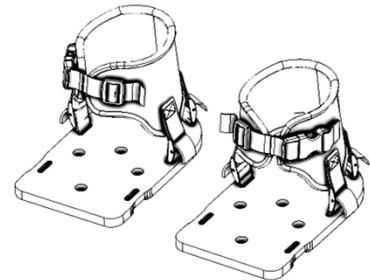

Shoe Sandals Padded Inserts Pair E0952

<input type="checkbox"/>	30653	Shoe Sandal Padded Inserts, X-Small	\$102.00
<input type="checkbox"/>	30654	Shoe Sandal Padded Inserts, Small	\$102.00
<input type="checkbox"/>	30655	Shoe Sandal Padded Inserts, Medium	\$102.00
<input type="checkbox"/>	30656	Shoe Sandal Padded Inserts, Large	\$102.00

2 Piece Padded Shoeholder Pair E0952

<input type="checkbox"/>	30147	Shoeholder w/ 2-Piece Removable 1/2" Thick Pad, 5" x 10", Pair	\$284.00
--------------------------	-------	----------------------------------------------------------------	----------

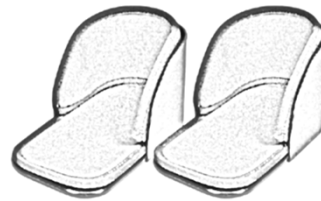

Padded Full Footbox Each K0108

<input type="checkbox"/>	30111	Footbox, Padded Full, Small	\$299.00
<input type="checkbox"/>	30112	Footbox, Padded Full, Medium	\$321.00
<input type="checkbox"/>	30113	Footbox, Padded Full, Large	\$321.00

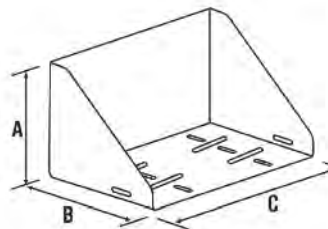

DIMENSIONS (inches)	A	B	C
SMALL	6"	8"	11"
MEDIUM	8"	10"	13"
LARGE	10"	12"	15"

Padded Split Footbox Pair K0108

<input type="checkbox"/>	30152	Footbox, Padded Split, Small	\$399.00
<input type="checkbox"/>	30153	Footbox, Padded Split, Medium	\$404.00
<input type="checkbox"/>	30154	Footbox, Padded Split, Large	\$411.00

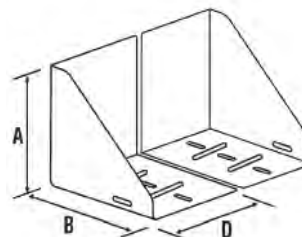

DIMENSIONS (inches)	A	B	D
SMALL	6"	8"	5.5"
MEDIUM	8"	10"	6.5"
LARGE	10"	12"	7.5"

Custom Padded Full Footbox Each K0108

- 70043 Footbox, Custom Full w/ Removable Padding \$ 1,363.00
- Box Material**
- 3/8" ABS (Standard)
- Other (Specify)
- Foam Thickness**
- 1/2" (Standard)
- 1"
- Other (Specify)
- Foam Type**
- Poly (Standard)
- Other (Specify)
- Cover Material**
- Soft Vinyl (Standard)
- Other (Specify)

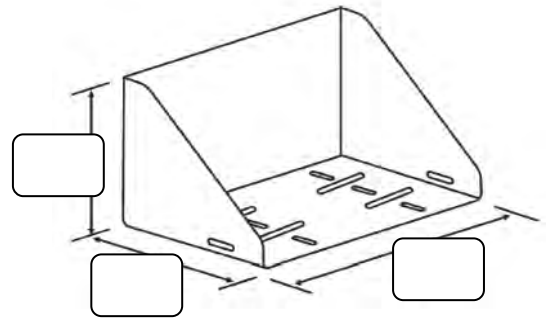

Custom Padded Split Footbox Pair K0108

- 70142 Footbox, Custom Split w/ Removable Padding \$ 1,363.00
- Box Material**
- 3/8" ABS (Standard)
- Other (Specify)
- Foam Thickness**
- 1/2" (Standard)
- 1"
- Other (Specify)
- Foam Type**
- Poly (Standard)
- Other (Specify)
- Cover Material**
- Soft Vinyl (Standard)
- Other (Specify)

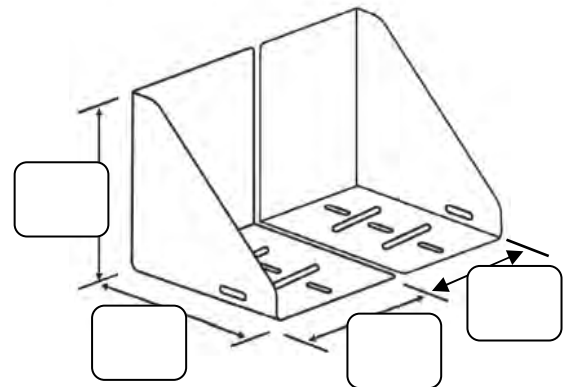

Toe Straps Pair E0952

- 30489 Toe Straps, Small 8" to 11.5" \$ 54.00
- 30490 Toe Straps, Medium 9" to 13.5" \$ 54.00
- 30491 Toe Straps, Large 10" to 15.5" \$ 54.00
- 50768 Soft Toe Strap with Buckle 1" , Pair \$ 56.00
- 50769 Soft Toe Strap with Buckle 1.5" , Pair \$ 56.00

Basic Leg Strap E0960

- 30398 Leg Strap, Basic, Single \$ 52.00
- 30399 Leg Strap, Basic, Pair \$ 97.00



Premium Calf Panel K0108

<input type="checkbox"/>	60038	Calf Panel, Premium, Small	\$ 96.00
<input type="checkbox"/>	60039	Calf Panel, Premium, Medium	\$ 96.00
<input type="checkbox"/>	60040	Calf Panel, Premium, Large	\$ 96.00
<input type="checkbox"/>	60044	Calf Panel, Premium, X-Large	\$175.00
<input type="checkbox"/>	60045	Calf Panel, Premium, 2X-Large	\$187.00

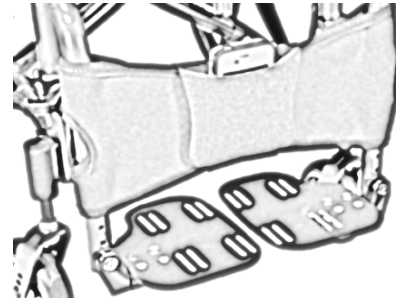

Pocket for Premium Calf Panel K0108

<input type="checkbox"/>	60041	Calf Panel Convenience Pocket, Small	\$ 30.00
<input type="checkbox"/>	60042	Calf Panel Convenience Pocket, Medium	\$ 30.00
<input type="checkbox"/>	60043	Calf Panel Convenience Pocket, Large	\$ 30.00

Calf Panel K0108

<input type="checkbox"/>	30485	Calf Panel, Standard, Small 11" x 4"	\$ 70.00
<input type="checkbox"/>	30486	Calf Panel, Standard, Medium 13" x 6"	\$ 70.00
<input type="checkbox"/>	30487	Calf Panel, Standard, Large 15" x 8"	\$ 70.00



Custom Calf Board K0108

<input type="checkbox"/>	60098	Custom Calf/Leg Board	\$206.00
--------------------------	-------	-----------------------	----------

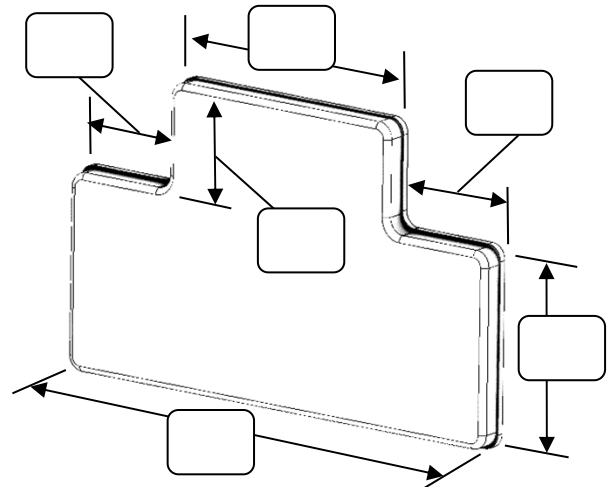

Custom Foot Plate Board K0108

<input type="checkbox"/>	52701	Custom Foot Plate Pad	\$231.00
--------------------------	-------	-----------------------	----------

