

9450 W. Laraway Rd.  
 Frankfort, IL 60423  
 P: 800-843-7234  
 F: 888-479-1515  
 www.therafin.com

## Seating Order Form

Client:

Account Number:

Shipping Address:

Mark For:

ATP:

PO#:

### Patient Dimensions

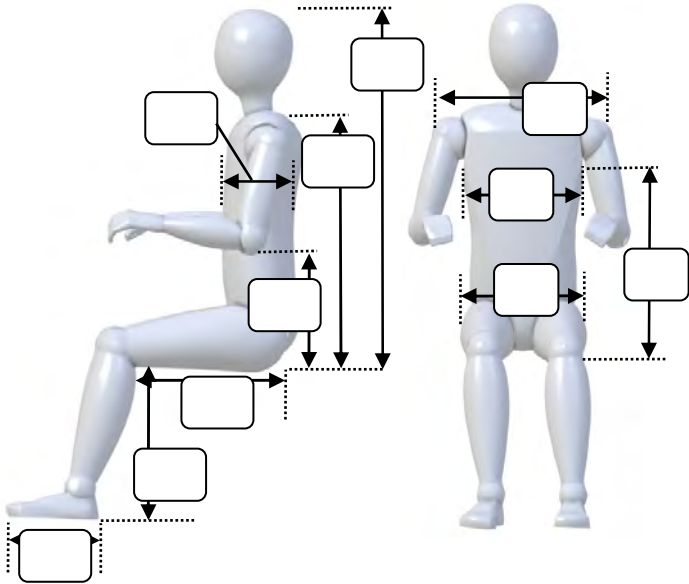

Chair Manuf.

Chair Model

Chair Width

Chair Depth

- No Assembly  
 Include Assembly

### Seat Dimensions

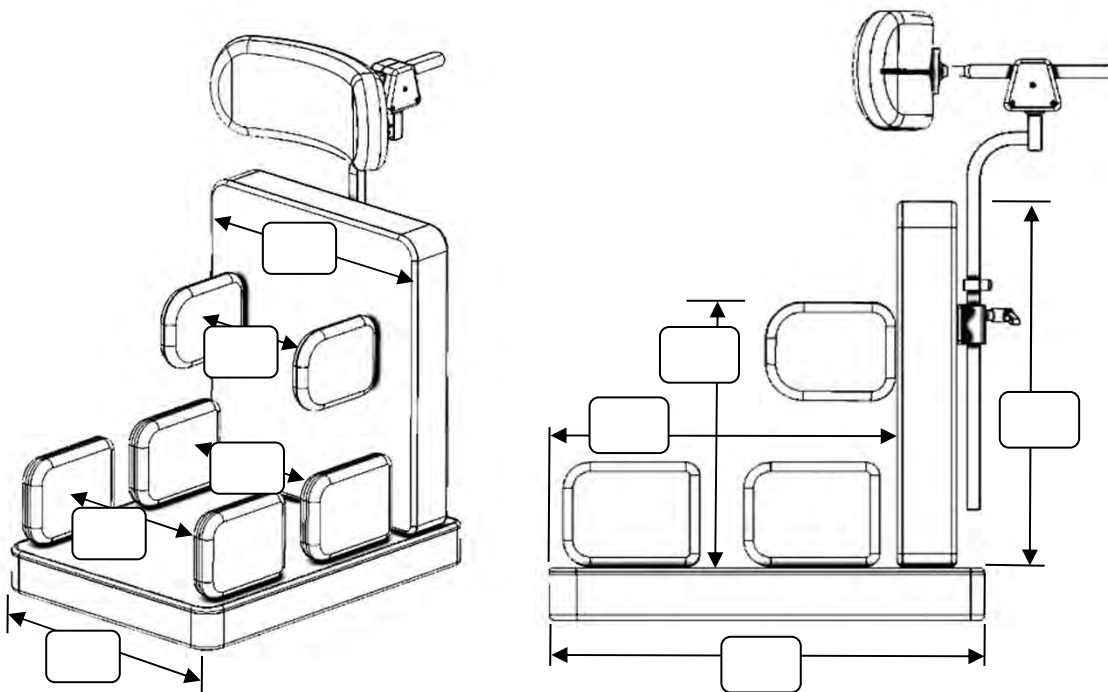

**Monogram Style**

N/C

**Monogram Text**

**Monogram Color**

N/C

**Fabric Color and Type**

N/C

Contact Selection

Non-Contact Selection

### Design Custom Seat

#### Choose Seat Fit

- Drop In Seat (Equals Chair width minus 2.75")
- Full Width Seat

#### Choose Seat Type E2609

- |                          |       |  |       |
|--------------------------|-------|--|-------|
| <input type="checkbox"/> | 71046 | Seat including Base, Foam & Cover        | \$529 |
| <input type="checkbox"/> | 71055 | Base Only                                | \$529 |
| <input type="checkbox"/> | 71047 | Cushion Only (includes hook and loop)    | \$529 |
| <input type="checkbox"/> | 71072 | Vinyl covered base with separate cushion | \$798 |

#### Select for Transit (Please select Seat Type First)

- 72054 Transit Seat (Must select Transit seat hdwr)

### Select Shape Modifications

#### Back Post Notch

- |                          |       |                                      |      |
|--------------------------|-------|--------------------------------------|------|
| <input type="checkbox"/> | 71085 | Growth Notches on base only (Hidden) | \$0  |
| <input type="checkbox"/> | 71009 | Growth Notches on base & seat        | \$93 |

#### I Shape

- |                          |       |                     |       |
|--------------------------|-------|---------------------|-------|
| <input type="checkbox"/> | 71026 | I Seat Modification | \$116 |
|--------------------------|-------|---------------------|-------|

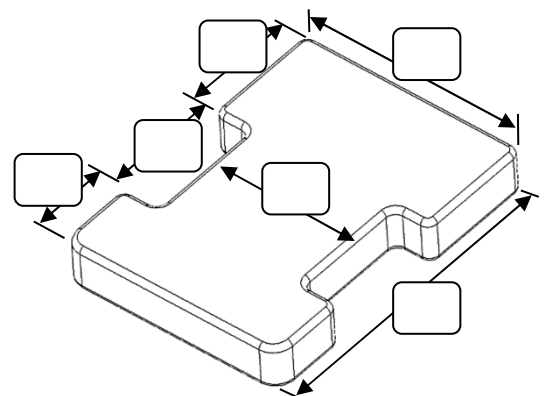
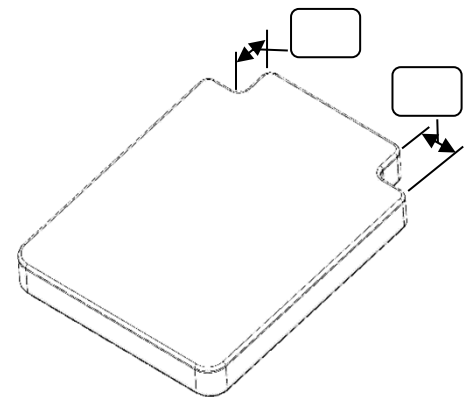

## Asymmetrical Shape

71008 Asymmetrical Seat \$105

Right Leg Shortened (use diagram below)

Include T-Nuts for Medial Thigh Support

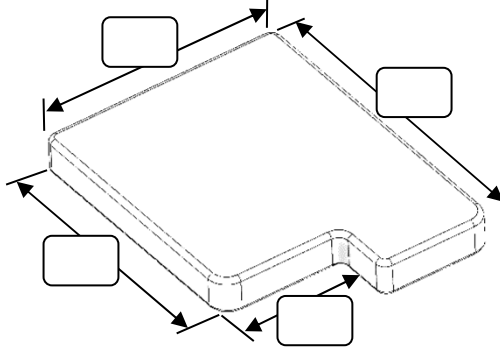

Left Leg Shortened (use diagram below)

Include T-Nuts for Medial Thigh Support

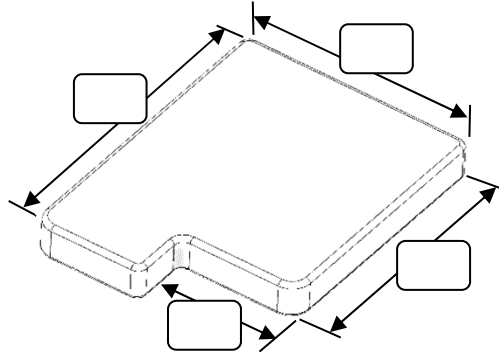

## Hamstring Relief

72060 Extended Foam \$116

72061 Shortened Base \$116

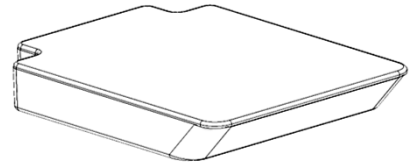

### Extended Foam



User Seat Depth PLUS 2" Foam Extended Out Front

### Shortened Base



User Seat Depth Cut Back 2"

## Select Contour Modifications

### Anti-Thrust Seat

71027 Anti-Thrust Seat \$93

72065 Add Depth Adjustability to Contour \$165  
*Standard contours*

Shallow Contour (1/2" Riser; C=2, F= 1.5) - provide D & D1

Medium Contour (1" Riser; C=2.5, F= 1.5)- provide D & D1

Deep Contour (1 1/2" Riser C=3 F= 1.5)- provide D & D1

Custom - provide dimensions on diagram

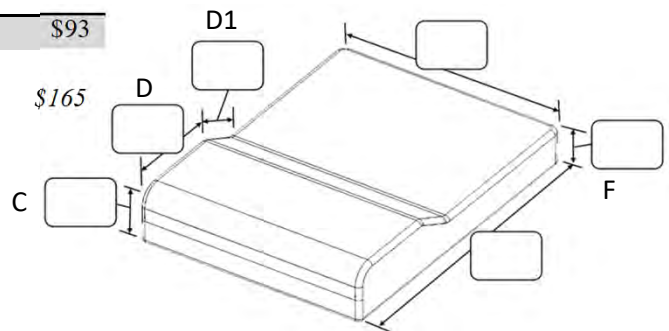

### Contoured Seats

71028 Contoured Seat With Leg Wells: \$192

72065 Add Depth Adjustability to Contour \$165  
*Standard contours*

Shallow (1/2" Riser/1/2" wedge; C=2.5, F= 1.5, G=2, H=2.5) - provide D

Medium (1" Riser/1/2" wedge; C=3, F= 1.5, G=2.5, H=3) - provide D

Deep (1" Riser/1" wedge; C=3.5, F= 1.5, G=2.5, H=3.5) - provide D

Custom - provide dimensions on diagram

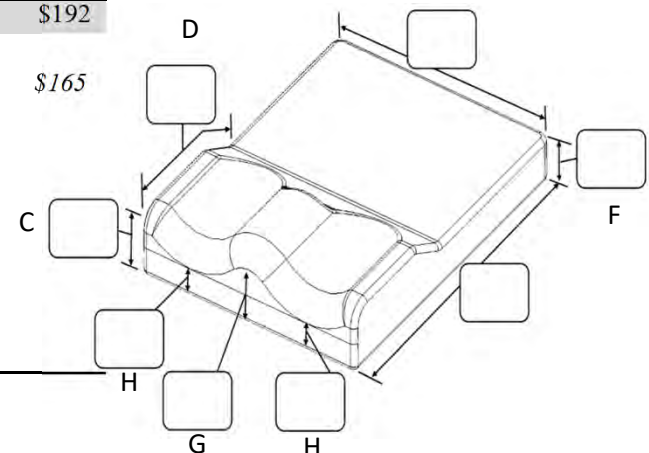

71029 Contoured Seat With Leg and Pelvic Wells: \$273

72065 Add Depth Adjustability to Contour \$165

**Standard contours**

Shallow (1/2" Riser/1/2" wedge; C=2.5, F= 2, G=2, H=2.5, J-1.5) - provide D

Medium (1" Riser/1/2" wedge; C=3, F= 2, G=2.5, H=3, J-1.5) - provide D

Deep (1" Riser/1" wedge; C=3.5, F= 2.5, G=2.5, H=3.5, J=11.5) - provide D

Custom - provide dimensions on diagram

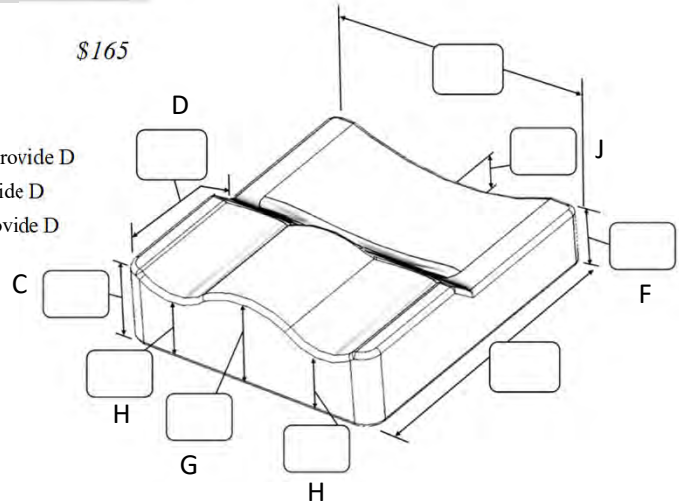

**Foam Modifications**

**Standard Foam**

Standard Foam: 1" soft over 1" medium (visco) \$0

Standard Contoured Foam: 1/2" soft over 1" medium \$0

**Substitute Foam**

72062 Use Poly Foam Instead of Visco Foam \$0

- 1/2"
- 1"
- 1 1/2"
- 2"

**Additional Foam**

71016 Additional 1/2" Visco Foam \$79

- XX-Soft T-Foam
- X-Soft
- Soft
- Medium

71017 Additional 1" Visco Foam \$116

- XX-Soft T-Foam
- X-Soft
- Soft
- Medium

71018 Additional 1/2" Pudgee Type Visco Foam \$192

71019 Additional 1" Pudgee Type Visco Foam \$247

71020 1/2" Gel Overlay, Flat \$247

71095 1/2" Gel Overlay, Cubed \$279

*\* note if gel is greater than 18x18 additional charges apply*

**Foam Modification**

71032 Mushroom Foam for Seat \$247

**Custom Foam Layering**

Top Layer

Middle Layer

Bottom Layer

*All foam up to 2" total thickness is included in base price of seat. Cost for custom foams is **only** applied when total thickness is greater than 2"*

# Cover Modifications

## Cover Modifications

<input type="checkbox"/>	71023	2" Hook-n-Loop Strips, sewn, pair	\$93
<input type="checkbox"/>	50252	Shower Cap Seat Cover	\$275
<input type="checkbox"/>	50252	Additional Cover for Seat (Identical cover)	\$275
<input type="checkbox"/>	72056	Dureflex Liner (Seat)	\$69

## Hardware

### 2 Knob (Hinged Clamp) (Incl with E2609)

<input type="checkbox"/>	50405	2 Knob with short slotted brackets	\$286
<input type="checkbox"/>	50470	2 Knob with long slotted brackets	\$286

### 2 Knob Wrap Around (Incl with E2609)

<input type="checkbox"/>	50467	2 Knob Wrap Around Kit, 7/8" and 1" tubing	\$332
<input type="checkbox"/>	50494	2 Knob Wrap Around Kit, 1 3/8" tubing	\$439

#### Transit

<input type="checkbox"/>	51077	2 Knob Wrap Ar. Transit Seat Hdwr. (7/8", 1")	\$454
<input type="checkbox"/>	51094	2 Knob Wrap Ar. Transit Seat Hdwr. (1-3/8")	\$618

### 4 Knob Wrap Around (Incl with E2609)

<input type="checkbox"/>	50468	4 Knob Wrap Around Seat Hardware(7/8", 1")	\$481
<input type="checkbox"/>	50495	4 Knob Wrap Around Seat Hardware(1-3/8")	\$579

#### Transit

<input type="checkbox"/>	51078	4 Knob Wrap Ar. Transit Seat Hdwr. (7/8", 1")	\$618
<input type="checkbox"/>	51095	4 Knob Wrap Ar. Transit Seat Hdwr. (1-3/8")	\$768

### Snap On Hardware (Incl with E2609)

<input type="checkbox"/>	50618	W/Raised Drop Hooks and Universal Rail Locks	\$180
<input type="checkbox"/>	50617	Snap On Seat Hardware - 2 Pair	\$181

### Drop Hook Kits

w/2 Rail Locks & 2 Hinged Collars (Incl with E2609)

\$ 176

w/4 Rail Locks (Incl with E2609)

\$ 176

w/2 Swing Tabs & 2 Hinged Collars (Incl with E2609)

\$ 182

w/2 Swing Tabs & 2 Rail Locks (Incl with E2609)

\$ 176

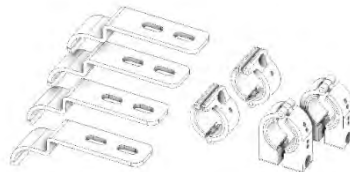
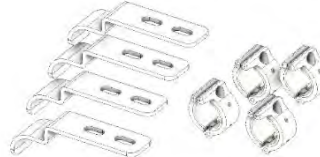
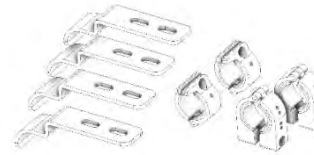
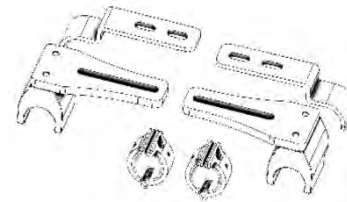
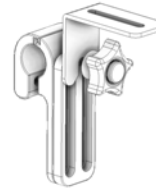
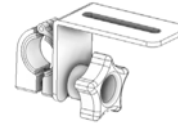

Choose Seat/Back Hinge when specifying the Back

# Design Custom Back

## Back Fabric Color and Type

N/C

Contact

Non-Contact

This dimension reduced by 2.75" if "Drop In Back" is selected

R Back Dimensions (synchronized with diagram on page 1)

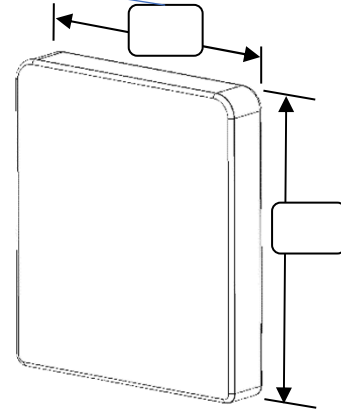

### Choose Back Fit

- Drop In Back (Equals Chair width minus 2.75")
- Full Width Back (Same as wheelchair width)

- 71013 Custom T Back Dimensions  
select box above and input dimensions

### Choose Back Type and Shape E2609

#### Base Foam and Cover - This is the most common back

- 71051 Rectangular Back including Base, Foam & Cover \$529
- 71052 T Back including Base, Foam & Cover \$529
- 71036 I Back including Base, Foam & Cover \$529

#### Base Only (Covered) - Plywood base no foam

- 71077 Rectangular Back Base Only \$529
- 71078 T Back Base Only \$529
- 71056 I Back Base Only \$529

#### Cushion Only (Covered) - No Plywood base

- 71080 Rectangular Cushion Only \$529
- 71081 T Back Cushion Only \$529
- 71079 I Back Cushion Only \$529

#### Vinyl Covered Base with Separate Cushion (Covered)

- 71075 Rectangular Base with Vinyl cover and Cushion \$798
- 71076 T Back Base with Vinyl cover and Cushion \$798
- 71073 I Back Base with Vinyl cover and Cushion \$798

### Select for Transit (Please select Back Type)

- 72055 Transit Seat (Must select Transit seat hdwr)

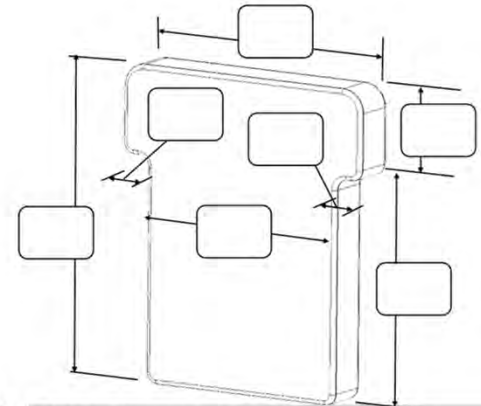

- 71011 Custom I Back Dimensions  
select box above and input dimensions

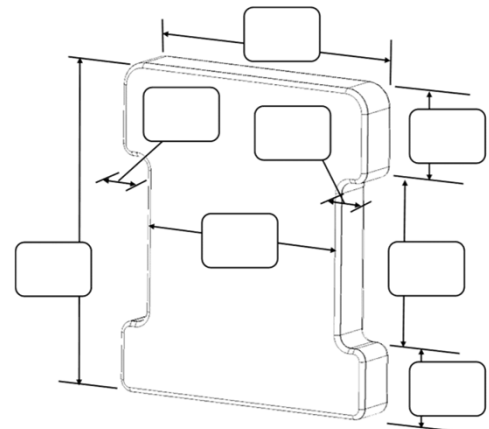

### Select Contour Modification

#### Curved Back Modification (Base is curved)

- 70169 Modify Rectangular Back for Curved Base \$205
- 70167 Modify T Back for Curved Base \$263
- 70166 Modify I Back for Curved Base \$278

**Contoured (Curved) Foam Modification (Base is flat)**

<input type="checkbox"/>	71002	Modify with 1/2" Contour	\$79
<input type="checkbox"/>	71003	Modify with 1" Contour	\$116
<input type="checkbox"/>	71004	Modify with Full Contour	\$126

**Bi-Angular Back**

<input type="checkbox"/>	71050	Bi-Angular Back Modification	\$402
--------------------------	-------	------------------------------	-------

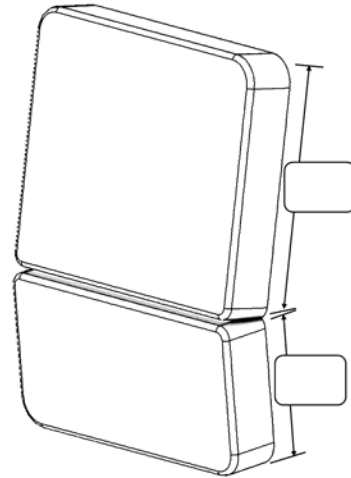

**Scapular Relief (Cutouts)**

<input type="checkbox"/>	71035	Scapular Relief Modification	\$158
--------------------------	-------	------------------------------	-------

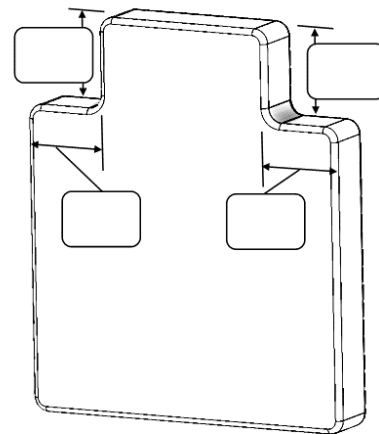

**Sacral Buildup**

<input type="checkbox"/>	72059	Sacral Buildup Modification	N/C
--------------------------	-------	-----------------------------	-----

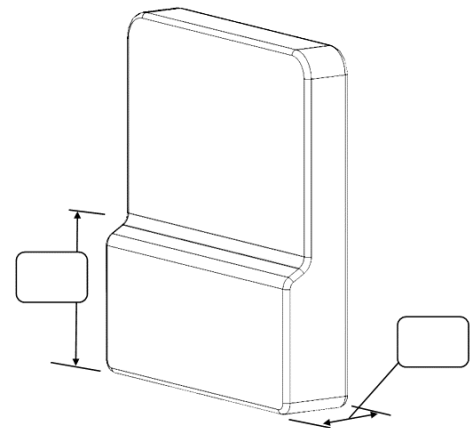

**Foam Modifications**

**Standard Foam**

<input type="checkbox"/>	Standard Foam: 1 1/2" soft (visco)		\$0
<input type="checkbox"/>	72062	Use Poly Foam Instead of Visco Foam	\$0

- 1/2"
- 1"
- 1 1/2"
- 2"

### Additional Foam

- |                          |                          |  |       |
|--------------------------|--------------------------|--|-------|
| <input type="checkbox"/> | 71016                    | Additional 1/2" Visco Foam             | \$79  |
|                          | <input type="checkbox"/> | XX-Soft T-Foam                         |       |
|                          | <input type="checkbox"/> | X-Soft                                 |       |
|                          | <input type="checkbox"/> | Soft                                   |       |
|                          | <input type="checkbox"/> | Medium                                 |       |
| <input type="checkbox"/> | 71017                    | Additional 1" Visco Foam               | \$116 |
|                          | <input type="checkbox"/> | XX-Soft T-Foam                         |       |
|                          | <input type="checkbox"/> | X-Soft                                 |       |
|                          | <input type="checkbox"/> | Soft                                   |       |
|                          | <input type="checkbox"/> | Medium                                 |       |
| <input type="checkbox"/> | 71018                    | Additional 1/2" Pudgee Type Visco Foam | \$192 |
| <input type="checkbox"/> | 71019                    | Additional 1" Pudgee Type Visco Foam   | \$247 |
| <input type="checkbox"/> | 71020                    | 1/2" Gel Overlay, Flat                 | \$247 |
| <input type="checkbox"/> | 71095                    | 1/2" Gel Overlay, Cubed                | \$279 |
- \* note if gel is greater than 18x18 additional charges a,*

### Foam Modifications

- |                          |       |                                      |       |
|--------------------------|-------|--------------------------------------|-------|
| <input type="checkbox"/> | 71032 | Mushroom Foam for Back               | \$247 |
| <input type="checkbox"/> | 71074 | Grid Foam, 2"                        | \$378 |
| <input type="checkbox"/> | 71091 | Grid Foam, 3"                        | \$415 |
| <input type="checkbox"/> | 50224 | 1/2 Unit Foam In Place Kit (w/bag)   | \$110 |
| <input type="checkbox"/> | 50226 | 1 Unit Foam In Place Kit (w/bag)     | \$219 |
| <input type="checkbox"/> | 50228 | 1 1/2 Unit Foam In Place Kit (w/bag) | \$274 |

Standard foam used with Foam-in-Place Kits = 1" soft visco glued to

### Custom Foam Layering

Top Layer

Middle Layer

Bottom Layer

**Select Foam-In-Place Cover  
Modification In Cover Modification  
Section**

*All foam up to 2" total thickness is  
included in base price of seat.  
Cost for custom foams is **only**  
applied when total thickness is  
greater than 2"*

### Cover Modifications

#### Cover Modifications

- |                          |       |   |       |
|--------------------------|-------|---|-------|
| <input type="checkbox"/> | 71007 | Foam-In_Place Cover (Specify Cover thickness) | \$93  |
| <input type="checkbox"/> | 72056 | Dureflex Liner                                | \$69  |
| <input type="checkbox"/> | 50251 | Additional Cover for Back (Identical cover)   | \$275 |
| <input type="checkbox"/> |       | Top Zipper Placement                          | N/C   |
| <input type="checkbox"/> | 71005 | Bottom Zipper Placement                       | N/C   |

#### Other Modifications

- |                          |       |  |      |
|--------------------------|-------|--|------|
| <input type="checkbox"/> | 71025 | Attach Channels to Back ( <i>Channels Selected Below</i> ) | \$93 |
| <input type="checkbox"/> | 50080 | Spreader Bar   | \$66 |

#### Select Back Channel

\$153

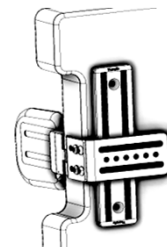



## Back Mounting Hardware

### Hardware WITH Seat/Back Hinge

#### FLUSH Seat/Back Hinge (qty 2) (Incl with E2617)

##### Molded J&L

<input type="checkbox"/>	51097	Molded J&Ls w/ Flush Hinges	\$ 268
--------------------------	-------	-----------------------------	--------

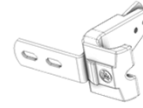

##### 2 Knob Hardware

<input type="checkbox"/>	50460	2 Knob w/ Flush Hinges	\$ 413
--------------------------	-------	------------------------	--------

##### 2 Knob Hardware for Curved Back (Curved Base)

*Back width*

12-13	<input type="checkbox"/>	50732	2 Knob w/ Flush Hinges (Curved Back)	\$ 470
14-15	<input type="checkbox"/>	50740	2 Knob w/ Flush Hinges (Curved Back)	\$ 470
16-17	<input type="checkbox"/>	50748	2 Knob w/ Flush Hinges (Curved Back)	\$ 470
17-18	<input type="checkbox"/>	50756	2 Knob w/ Flush Hinges (Curved Back)	\$ 470

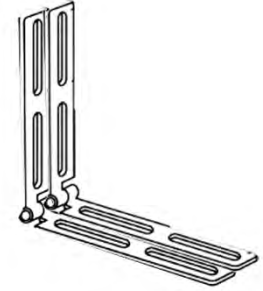
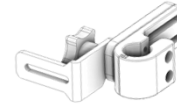

##### 2 Knob Hardware TRANSIT

<input type="checkbox"/>	51082	2 Knob Transit w/ Flush Hinges	\$ 448
--------------------------	-------	--------------------------------	--------

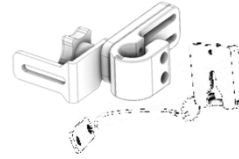

#### OFFSET Seat/Back Hinge: 2" Rise, 1" O/S (Incl with E2617)

##### Molded J&L

<input type="checkbox"/>	51098	Molded J&Ls w/2" Rise, 1" O/S Hinge	\$ 268
--------------------------	-------	-------------------------------------	--------

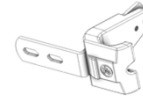

##### 2 Knob Hardware

<input type="checkbox"/>	50461	2 Knob w/2" Rise, 1" O/S Hinge	\$ 413
--------------------------	-------	--------------------------------	--------

##### 2 Knob Hardware for Curved Back (Curved Base)

*Back width*

12-13	<input type="checkbox"/>	50733	2 Knob w/2" Rise, 1" O/S Hinge	\$ 470
14-15	<input type="checkbox"/>	50741	2 Knob w/2" Rise, 1" O/S Hinge	\$ 470
16-17	<input type="checkbox"/>	50749	2 Knob w/2" Rise, 1" O/S Hinge	\$ 470
17-18	<input type="checkbox"/>	50757	2 Knob w/2" Rise, 1" O/S Hinge	\$ 470

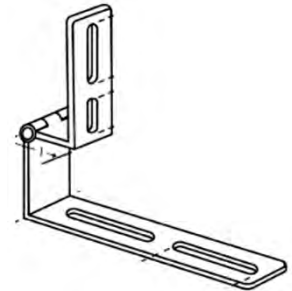

##### 2 Knob Hardware TRANSIT

<input type="checkbox"/>	51083	2 Knob Transit w/2" Rise, 1" O/S Hinge	\$ 448
--------------------------	-------	--	--------

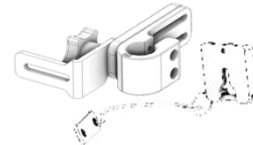

#### OFFSET Seat/Back Hinge: 2" Rise, 2" O/S (Incl with E2617)

##### Molded J&L

<input type="checkbox"/>	51099	Molded J&Ls w/2" Rise, 2" O/S Hinge	\$ 268
--------------------------	-------	-------------------------------------	--------

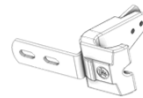

##### 2 Knob Hardware

<input type="checkbox"/>	50462	2 Knob w/2" Rise, 2" O/S Hinge	\$ 413
--------------------------	-------	--------------------------------	--------

##### 2 Knob Hardware for Curved Back (Curved Base)

*Back width*

12-13	<input type="checkbox"/>	50734	2 Knob w/2" Rise, 2" O/S Hinge	\$ 470
14-15	<input type="checkbox"/>	50742	2 Knob w/2" Rise, 2" O/S Hinge	\$ 470
16-17	<input type="checkbox"/>	50750	2 Knob w/2" Rise, 2" O/S Hinge	\$ 470
17-18	<input type="checkbox"/>	50758	2 Knob w/2" Rise, 2" O/S Hinge	\$ 470

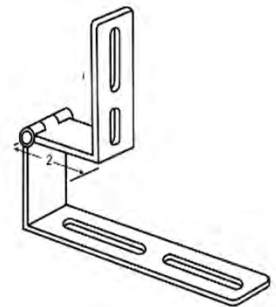
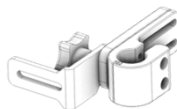

##### 2 Knob Hardware TRANSIT

<input type="checkbox"/>	51084	2 Knob Transit w/2" Rise, 2" O/S Hinge	\$ 448
--------------------------	-------	--	--------

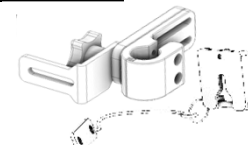

**OFFSET Seat/Back Hinge: 2" Rise, 3" O/S (Incl with E2617)**

**Molded J&L**

<input type="checkbox"/>	51100	Molded J&Ls w/2" Rise, 3" O/S Hinge	\$ 268
--------------------------	-------	-------------------------------------	--------

**2 Knob Hardware**

<input type="checkbox"/>	50463	2 Knob w/2" Rise, 3" O/S Hinge	\$ 413
--------------------------	-------	--------------------------------	--------

**Back width**

**2 Knob Hardware for Curved Back (Curved Base)**

12-13	<input type="checkbox"/>	50735	2 Knob w/2" Rise, 3" O/S Hinge	\$ 470
-------	--------------------------	-------	--------------------------------	--------

14-15	<input type="checkbox"/>	50743	3 Knob w/2" Rise, 3" O/S Hinge	\$ 470
-------	--------------------------	-------	--------------------------------	--------

16-17	<input type="checkbox"/>	50751	2 Knob w/2" Rise, 3" O/S Hinge	\$ 470
-------	--------------------------	-------	--------------------------------	--------

17-18	<input type="checkbox"/>	50759	2 Knob w/2" Rise, 3" O/S Hinge	\$ 470
-------	--------------------------	-------	--------------------------------	--------

**2 Knob Hardware TRANSIT**

<input type="checkbox"/>	51085	2 Knob Transit w/2" Rise, 3" O/S Hinge	\$ 448
--------------------------	-------	--	--------

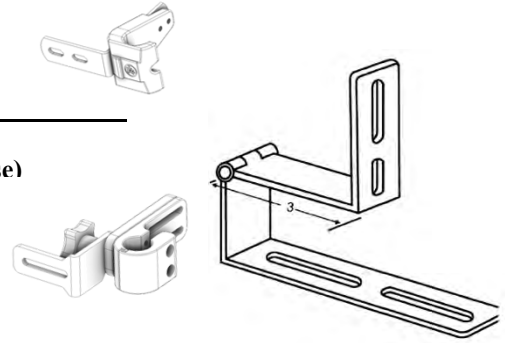

**OFFSET Seat/Back Hinge: 3" Rise, 1" O/S (Incl with E2617)**

**Molded J&L**

<input type="checkbox"/>	51102	Molded J&Ls w/3" Rise, 1" O/S Hinge	\$ 268
--------------------------	-------	-------------------------------------	--------

**2 Knob Hardware**

<input type="checkbox"/>	50464	2 Knob w/3" Rise, 1" O/S Hinge	\$ 413
--------------------------	-------	--------------------------------	--------

**Back width**

**2 Knob Hardware for Curved Back (Curved Base)**

12-13	<input type="checkbox"/>	50736	2 Knob w/3" Rise, 1" O/S Hinge	\$ 470
-------	--------------------------	-------	--------------------------------	--------

14-15	<input type="checkbox"/>	50744	2 Knob w/3" Rise, 1" O/S Hinge	\$ 470
-------	--------------------------	-------	--------------------------------	--------

16-17	<input type="checkbox"/>	50752	2 Knob w/3" Rise, 1" O/S Hinge	\$ 470
-------	--------------------------	-------	--------------------------------	--------

17-18	<input type="checkbox"/>	50760	2 Knob w/3" Rise, 1" O/S Hinge	\$ 470
-------	--------------------------	-------	--------------------------------	--------

**2 Knob Hardware TRANSIT**

<input type="checkbox"/>	51086	2 Knob Transit w/3" Rise, 1" O/S Hinge	\$ 448
--------------------------	-------	--	--------

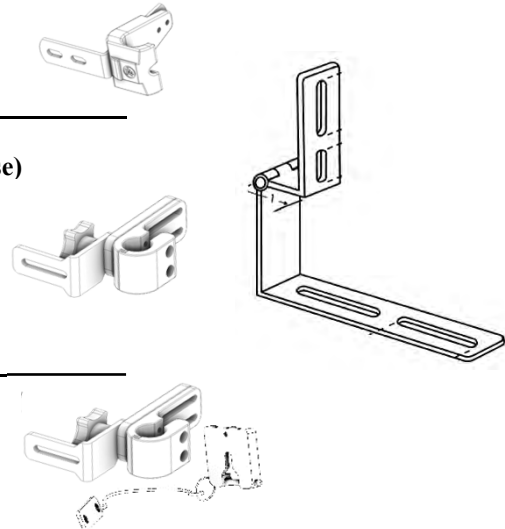

**OFFSET Seat/Back Hinge: 3" Rise, 2" O/S (Incl with E2617)**

**Molded J&L**

<input type="checkbox"/>	51103	Molded J&Ls w/3" Rise, 2" O/S Hinge	\$ 268
--------------------------	-------	-------------------------------------	--------

**2 Knob Hardware**

<input type="checkbox"/>	50465	2 Knob w/3" Rise, 2" O/S Hinge	\$ 413
--------------------------	-------	--------------------------------	--------

**Back width**

**2 Knob Hardware for Curved Back (Curved Base)**

12-13	<input type="checkbox"/>	50737	2 Knob w/3" Rise, 2" O/S Hinge	\$ 470
-------	--------------------------	-------	--------------------------------	--------

14-15	<input type="checkbox"/>	50745	2 Knob w/3" Rise, 2" O/S Hinge	\$ 470
-------	--------------------------	-------	--------------------------------	--------

16-17	<input type="checkbox"/>	50753	2 Knob w/3" Rise, 2" O/S Hinge	\$ 470
-------	--------------------------	-------	--------------------------------	--------

17-18	<input type="checkbox"/>	50761	2 Knob w/3" Rise, 2" O/S Hinge	\$ 470
-------	--------------------------	-------	--------------------------------	--------

**2 Knob Hardware TRANSIT**

<input type="checkbox"/>	51087	2 Knob Transit w/3" Rise, 2" O/S Hinge	\$ 448
--------------------------	-------	--	--------

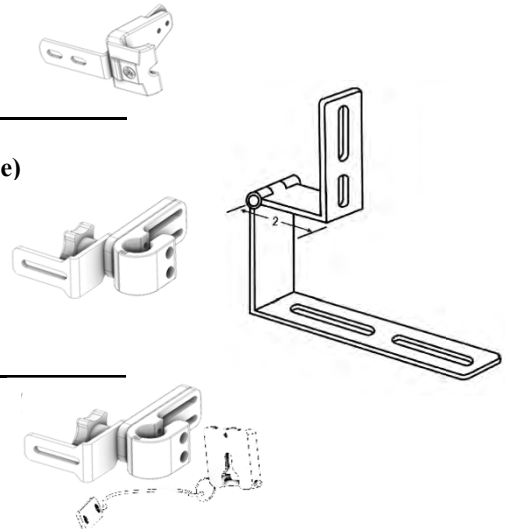

**OFFSET Seat/Back Hinge: 3" Rise, 3" O/S (Incl with E2617)**

**Molded J&L**

<input type="checkbox"/>	51104	Molded J&Ls w/3" Rise, 3" O/S Hinge	\$ 268
--------------------------	-------	-------------------------------------	--------

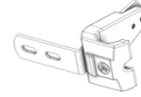

**2 Knob Hardware**

<input type="checkbox"/>	50466	2 Knob w/3" Rise, 3" O/S Hinge	\$ 413
--------------------------	-------	--------------------------------	--------

**2 Knob Hardware for Curved Back (Curved Base)**

*Back width*

12-13	<input type="checkbox"/>	50738	2 Knob w/3" Rise, 3" O/S Hinge	\$ 470
-------	--------------------------	-------	--------------------------------	--------

14-15	<input type="checkbox"/>	50746	2 Knob w/3" Rise, 3" O/S Hinge	\$ 470
-------	--------------------------	-------	--------------------------------	--------

16-17	<input type="checkbox"/>	50754	2 Knob w/3" Rise, 3" O/S Hinge	\$ 470
-------	--------------------------	-------	--------------------------------	--------

17-18	<input type="checkbox"/>	50762	2 Knob w/3" Rise, 3" O/S Hinge	\$ 470
-------	--------------------------	-------	--------------------------------	--------

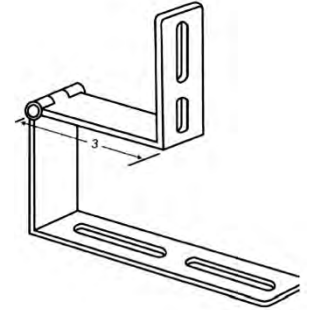
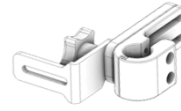

**2 Knob Hardware TRANSIT**

<input type="checkbox"/>	51088	2 Knob Transit w/3" Rise, 3" O/S Hinge	\$ 448
--------------------------	-------	--	--------

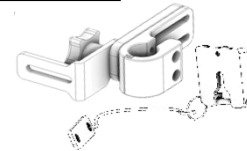

**OFFSET Seat/Back Hinge: 2.5" Rise, Adjustable O/S (Incl with E2617)**

**Molded J&L**

<input type="checkbox"/>	51101	Molded J&Ls w/2.5" Rise, Adj O/S Hin	\$ 441
--------------------------	-------	--------------------------------------	--------

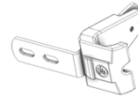

**2 Knob Hardware**

<input type="checkbox"/>	51093	2 Knob w/2.5" Rise, Adj O/S Hinge	\$ 525
--------------------------	-------	-----------------------------------	--------

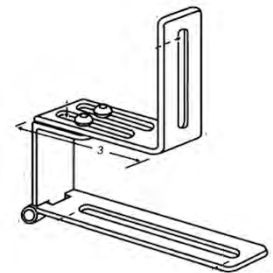
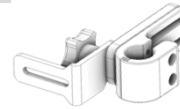

**2 Knob Hardware TRANSIT**

<input type="checkbox"/>	51090	2 Knob Transit w/2.5 Rise, Adj O/S Hin;	\$ 593
--------------------------	-------	---	--------

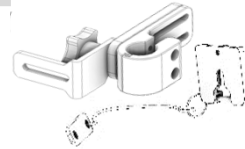

**OFFSET 2 Seat/Back Hinges: 2.5" Rise, Adjustable O/S (Incl with E2617)**

**2 Knob Hardware**

<input type="checkbox"/>	51092	2 Knob w/2.5" Rise, Adj O/S Hinge	\$ 525
--------------------------	-------	-----------------------------------	--------

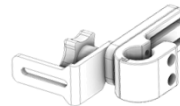

**2 Knob Hardware TRANSIT**

<input type="checkbox"/>	51089	2 Knob w/2.5" Rise, Adj O/S Hinge	\$ 593
--------------------------	-------	-----------------------------------	--------

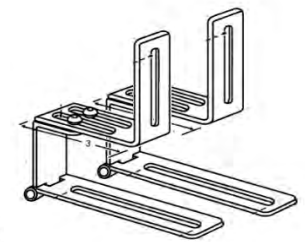

**Hardware WITHOUT Seat/Back Hinge**

**4 Knob Hardware (Incl with E2617)**

**4 Knob Hardware**

<input type="checkbox"/>	50473	4 Knob Hardware	\$ 475
--------------------------	-------	-----------------	--------

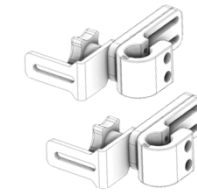

**4 Knob Hardware for Curved Back (Curved Base)**

*Back width*

12-13	<input type="checkbox"/>	50739	4 Knob Hardware (Curved Back)	\$ 540
-------	--------------------------	-------	-------------------------------	--------

14-15	<input type="checkbox"/>	50747	4 Knob Hardware (Curved Back)	\$ 540
-------	--------------------------	-------	-------------------------------	--------

16-17	<input type="checkbox"/>	50755	4 Knob Hardware (Curved Back)	\$ 540
-------	--------------------------	-------	-------------------------------	--------

17-18	<input type="checkbox"/>	50763	4 Knob Hardware (Curved Back)	\$ 540
-------	--------------------------	-------	-------------------------------	--------

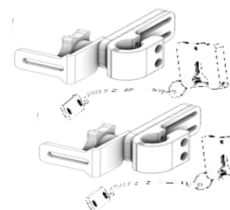

**4 Knob Hardware TRANSIT**

<input type="checkbox"/>	51076	4 Knob Transit	\$ 655
--------------------------	-------	----------------	--------

**4 Molded J and L Hardware (Incl with E2617)**

<input type="checkbox"/>	50475	Slotted L Brackets, w/ Swingtabs	\$ 268
<input type="checkbox"/>	50499	Heavy Duty, w/ Swingtabs	\$ 297
<input type="checkbox"/>	50469	Long Slotted L Brackets, w/ Swingtabs	\$ 340

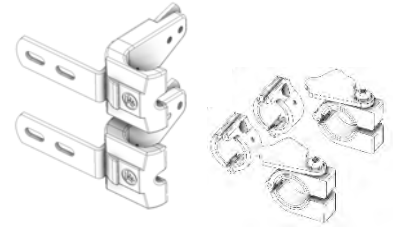

**Drop Hook Kits**

**w/2 Rail Locks & 2 Hinged Swing Collars (Incl with E2609)**

\$181



**w/4 Rail Locks (Incl with E2609)**

\$181



# Head Supports

## Brackets

### Multi-Axis Offset E1028

- 50215 Headrest Hardware, Multi-Axis \$255.00



### Surelock E1028

- 50218 Headrest Hardware, Surelock Square Bar \$249.00

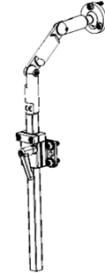

### Flip Down E1028

- 50230 Headrest Hrdw, Flip-Down w/Ball Mount \$274.00

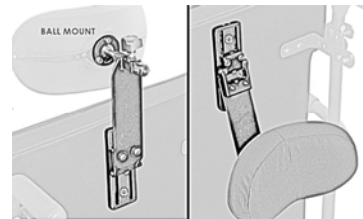

### Flip Down E1028

- 50229 Headrest Hrdw, Flip-Down w/Flat Mount \$274.00

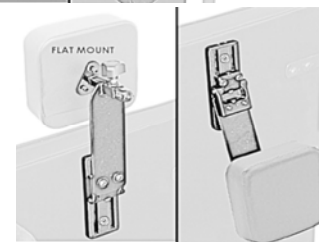

### Basic Hardware E1028

- 50413 Basic w/ Short 4" Horizontal Bar \$146.00
- 50414 Basic w/ Long 7" Horizontal Bar \$146.00

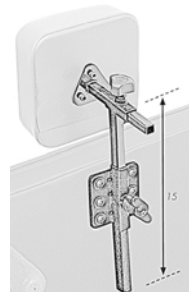

### Bracket Options K0108

- 32825 Headrest Universal Adaptor Plate \$117.00

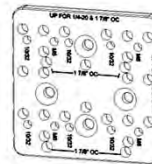

- 32975 Headrest Hardware, Horizontal Slide Mount \$ 98.00

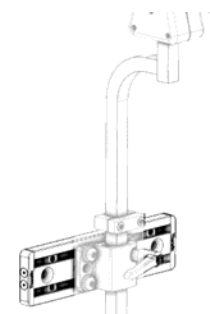

## Pads

### Profit Adjust E0955

- 50361 Pro-Fit Adjust w/ Knit Cover, Large \$305.00
- 50363 Pro-Fit Adjust w/ Knit Cover, Small \$305.00
- 50368 Pro-Fit Adjust w/ Smooth Cover, Small \$305.00
- 50369 Pro-Fit Adjust w/ Smooth Cover, Large \$305.00

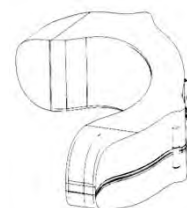

### Profit Soft Pad E0955

- 50365 Pro-Fit Soft Pad w/ Smooth Cover, 5 x 8 \$157.00
- 50366 Pro-Fit Soft Pad w/ Smooth Cover, 5 x 10 \$157.00
- 50367 Pro-Fit Soft Pad w/ Smooth Cover, 5 x 14 \$157.00

---

- 50374 Pro-Fit Soft Pad w/ Knit Cover, 4 x 8 \$157.00
- 50375 Pro-Fit Soft Pad w/ Knit Cover, 4 x 10 \$157.00
- 50376 Pro-Fit Soft Pad w/ Knit Cover, 4 x 14 \$157.00

### Flat Pad E0955

- 50477 Headrest Pad, Flat w/ Smooth Cover, 5" x 5" \$147.00
- 50478 Headrest Pad, Flat w/ Smooth Cover, 6" x 6" \$147.00
- 50479 Headrest Pad, Flat w/ Smooth Cover, 8" x 8" \$147.00

### Molded Pads E0955

### Curved Tri-Form Headrest E0955 and K0108

*Must select all 3 boxes*

- 32458C Tri-form, Center Section E0955 \$237.00
- 32458L Tri-form, Curved, Left Side K0108 \$199.00
- 32458R Tri-form, Curved, Right Side K0108 \$199.00

### Flat Tri-Form Headrest E0955 and K0108

*Must select all 3 boxes*

- 32414C Tri-form, Center Section E0955 \$244.00
- 32414L Tri-form, Straight, Left Side K0108 \$160.00
- 32414R Tri-form, Straight, Right Side K0108 \$160.00

### Custom Tri-Form Headrest E0955 and K0108

*Must select all 3 boxes*

- 50373C Tri-form, Custom Center Section E0955 \$237.00
- 50373L Tri-form, Custom Side Section, Left K0108 \$277.00
- 50373R Tri-form, Custom Side Section, Right K0108 \$277.00

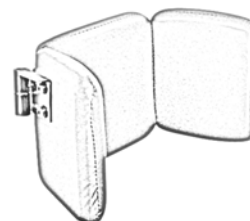
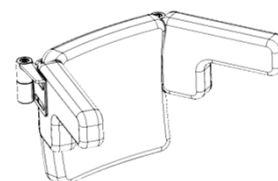
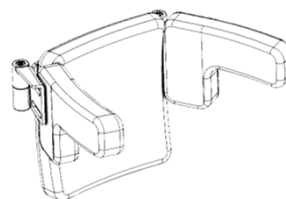
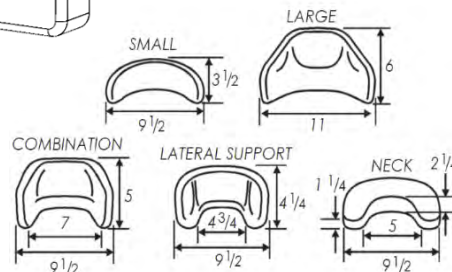
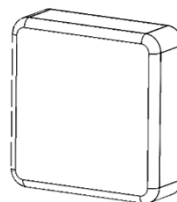
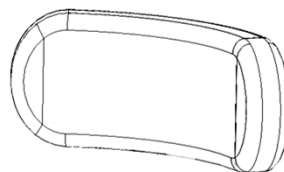
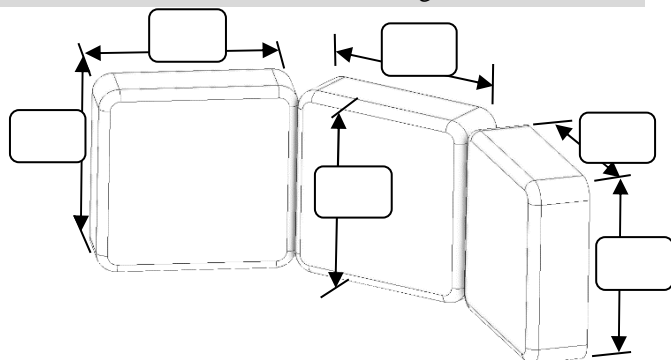

### Headrest Parts K0108

- 32967 Headrest Mounting Plate w/ Lever \$ 45.00

---

- 32477 Headrest Hardware, Surelock Extension Bar \$103.00

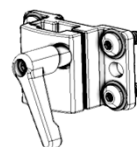

## Lateral Thoracic Supports

### VALUE Lateral Thoracic Pad E0956 Ea.

**FLAT**

*These pads have Black Smooth Dartex Face and Neoprene Knit Back Side*

**LEFT**

**RIGHT** *Molded Pads are self skinning molded foam with Neoprene cover*



**CURVED**

*These pads have Black Smooth Dartex Face and Neoprene Knit Back Side*

**LEFT**

**RIGHT** *Molded Pads are self skinning molded foam with Neoprene cover*



### NEOPRENE/VINYL Lateral Thoracic Pad E0956 Ea.

**FLAT**

*These pads have Black Neoprene Face and Vinyl Back Side*

**LEFT**

**RIGHT**



### TRU SPEC Lateral Thoracic Pad E0956 Ea.

**FLAT**

*These pads can have custom fabrics and colors*

**LEFT**

**RIGHT** *Select fabrics and colors on next page*



**CURVED**

*These pads can have custom fabrics and colors*

**LEFT**

**RIGHT** *Select fabrics and colors on next page*



### CUSTOM Lateral Thoracic Pad E0956 Ea.

**LEFT**

**RIGHT**

*For Custom Pad select fabrics and colors below*

<input type="checkbox"/> None	<input type="checkbox"/> None		
<input type="checkbox"/> 50055	<input type="checkbox"/> 50055	<b>Flat Custom Pad</b>	\$ 145
<input type="checkbox"/> 50060	<input type="checkbox"/> 50060	<b>Curved Custom Pad</b>	\$ 169

**LEFT**

**RIGHT**

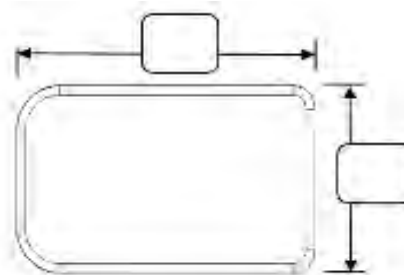
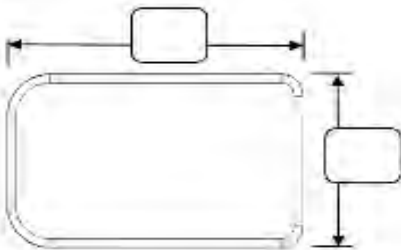

### Pad Modifications Ea.

<input type="checkbox"/> 71068	Modification Extra Foam	\$ 26
	<input type="checkbox"/> XX-Soft	
	<input type="checkbox"/> X-Soft	
	<input type="checkbox"/> Soft	
	<input type="checkbox"/> Medium	

**Pad Modifications Ea. (Continued)**

<input type="checkbox"/>	71067	Modification add Gel 1/4"	\$	39
<input type="checkbox"/>	71092	Modification add 1/2" Pudgee Foam	\$	37
<input type="checkbox"/>	71069	Mushroom Foam on Pad	\$	39

**Custom Foam Layering**

Top Layer

Middle Layer

**Lateral Thoracic Pad Fabric Color and Type**

N/C

Contact Non-Contact

**Fixed Bracket Each E0956 (Must select Flat Pad)**

LEFT RIGHT *Fixed Brackets CANNOT be used with a curved pad*

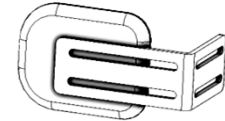

**Fixed MODULAR Bracket Each E0956 (Must select Flat Pad)**

LEFT RIGHT *Part numbers will sometime vary depending on bracket setup needs*

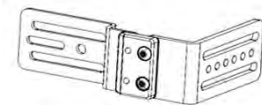

**Swing Away Hardware Each E1028**

LEFT RIGHT *Part numbers wil sometime vary depending on bracket setup needs*

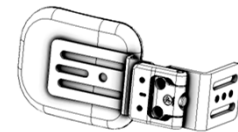

**Proximal Swing Away Hardware Each E1028**

LEFT RIGHT *Part numbers wil sometime vary depending on bracket setup needs*

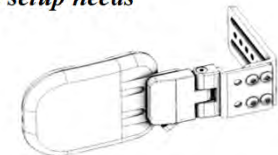

**Spacers (1/2" Each) Each K0108**

LEFT		RIGHT			
Qty		Qty			
	50098		50098	Spacer (1/2")	\$ 25

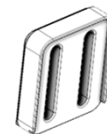

**Pin Style Summer/Winter Hardware Each K0108**

LEFT		RIGHT			
<input type="checkbox"/>	50325	<input type="checkbox"/>	50325	Summer/Winter Hardware	\$ 100
<i>(Must order channels on back)</i>					

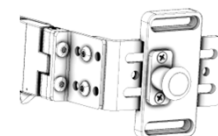

**Low Profile Summer/Winter Hardware Each K0108**

LEFT		RIGHT			
<input type="checkbox"/>	50324	<input type="checkbox"/>	50324	Summer/Winter Hardware	\$ 73
<i>(Must order channels on back)</i>					

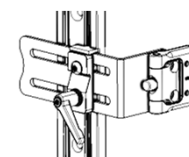



# REAR Lateral Hip Supports

For FRONT Setup see section two pages below

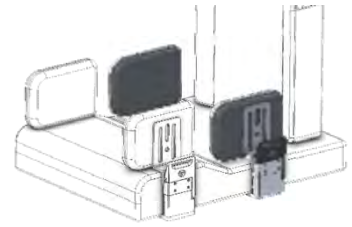

## Standard Lateral Hip Pad E0956 Ea.

LEFT	RIGHT	<i>These pads have Black Smooth Dartex Face and Neoprene Knit Back Side</i>	
<input type="checkbox"/> 50144	<input type="checkbox"/> 50144	Hip Guide, Flat, 3 x 4	\$ 83
<input type="checkbox"/> 50145	<input type="checkbox"/> 50145	Hip Guide, Flat, 3 x 5	\$ 83
<input type="checkbox"/> 50146	<input type="checkbox"/> 50146	Hip Guide, Flat, 4 x 5	\$ 83
<input type="checkbox"/> 50147	<input type="checkbox"/> 50147	Hip Guide, Flat, 4 x 6	\$ 83
<input type="checkbox"/> 50148	<input type="checkbox"/> 50148	Hip Guide, Flat, 4 x 8	\$ 83
<input type="checkbox"/> 50246	<input type="checkbox"/> 50246	Hip Guide, Flat, 4 x 10	\$ 89
<input type="checkbox"/> 50247	<input type="checkbox"/> 50247	Hip Guide, Flat, 4 x 12	\$ 89
<input type="checkbox"/> 50268	<input type="checkbox"/> 50268	Hip Guide, Flat, 4 x 14	\$ 93
<input type="checkbox"/> 50276	<input type="checkbox"/> 50276	Hip Guide, Flat, 4 x 16	\$ 93
<input type="checkbox"/> 50343	<input type="checkbox"/> 50343	Hip Guide, Flat, 4 x 18	\$ 93

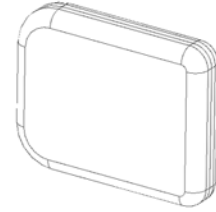

## Custom Lateral Hip Pad E0956 Ea.

LEFT	RIGHT	<i>For Custom Pad select fabrics next page</i>	
<input type="checkbox"/> 73001	<input type="checkbox"/> 73001	Hip Pad, TrU-Spec Non-Contoured	\$ 121

LEFT

RIGHT

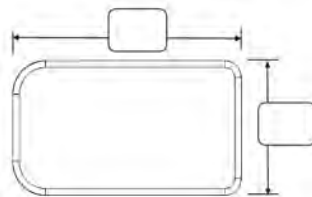
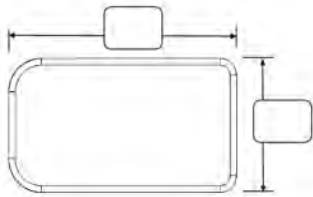

LEFT	RIGHT	<i>For Custom Pad select fabrics next page</i>	
<input type="checkbox"/> 73002	<input type="checkbox"/> 73002	Hip Guide, Custom Contoured	\$ 155

LEFT

RIGHT

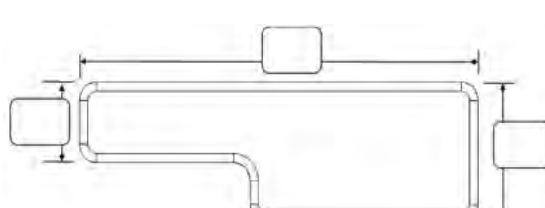
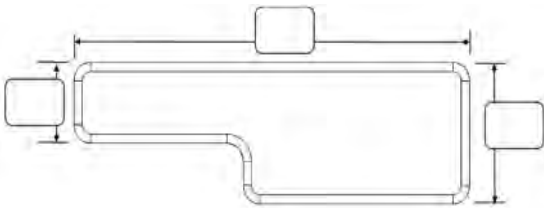

## Pad Modifications Ea.

<input type="checkbox"/> 71068	Modification Extra Foam	\$ 26
	<input type="checkbox"/> XX-Soft	
	<input type="checkbox"/> X-Soft	
	<input type="checkbox"/> Soft	
	<input type="checkbox"/> Medium	
<input type="checkbox"/> 71067	Modification add Gel 1/4"	\$ 39

Set Pad FLUSH with Front of Seat N/C

Set Pad BACK from Front Edge *Indicate distance in Box at right* N/C

Set Pad BEYOND of Front Edge *Indicate distance in Box at right* N/C

Distance

Distance

# Rear Hip Pad Fabric Color and Type

N/C

Contact

Non-Contact

## Spacers (1/2" Each) Each K0108

LEFT RIGHT

Qty		Qty			
50098		50098	Spacer (1/2")	\$	25

## Fixed Bracket Each E0956

LEFT RIGHT

## Adjustable Angle Bracket Each E0956

LEFT RIGHT

## Removable Bracket (Non-Locking) Each E1028

LEFT RIGHT

## Flip Down Bracket Each E1028

LEFT RIGHT

<input type="checkbox"/>	31397	<input type="checkbox"/>	31397	Flip Down for Quantum	\$	161
--------------------------	-------	--------------------------	-------	-----------------------	----	-----

## SEAT MOUNT Locking Removable Bracket Each E1028

Select Offset, and Seat Thickness - Pad Mount Bracket is 3" Long

LEFT RIGHT

Select Offset, and Seat Thickness - Pad Mount Bracket is 5" Long

LEFT RIGHT

## CHANNEL MOUNT Locking Removable Bracket Each E1028

Select Offset, and Seat Thickness - Pad Mount Bracket is 3" Long

LEFT RIGHT

Select Offset, and Seat Thickness - Pad Mount Bracket is 5" Long

LEFT RIGHT

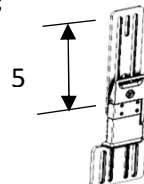
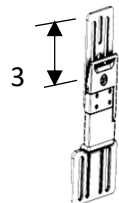
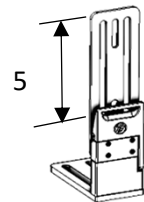
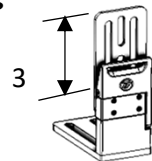
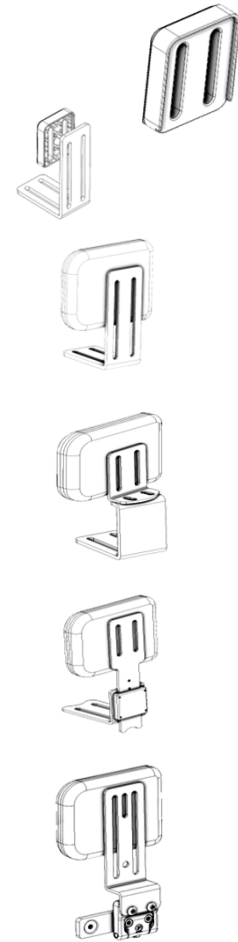

# FRONT Lateral Hip Supports

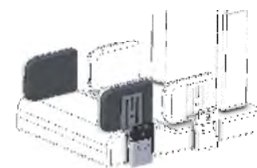

## Standard Lateral Hip Pad E0956 Ea.

LEFT		RIGHT		<i>These pads have Black Smooth Dartex Face and Neoprene Knit Back Side</i>	
<input type="checkbox"/>	50270	<input type="checkbox"/>	50270	Hip Guide, Flat, 3 x 4	\$ 84
<input type="checkbox"/>	50271	<input type="checkbox"/>	50271	Hip Guide, Flat, 3 x 5	\$ 84
<input type="checkbox"/>	50272	<input type="checkbox"/>	50272	Hip Guide, Flat, 4 x 5	\$ 84
<input type="checkbox"/>	50273	<input type="checkbox"/>	50273	Hip Guide, Flat, 4 x 6	\$ 84
<input type="checkbox"/>	50275	<input type="checkbox"/>	50275	Hip Guide, Flat, 4 x 8	\$ 84



## Custom Lateral Hip Pad E0956 Ea.

LEFT	RIGHT	<i>For Custom Pad select fabrics next page</i>	
<input type="checkbox"/>	73004	<input type="checkbox"/>	73004 Hip Pad, TrU-Spec Non-Contoured \$ 121

LEFT

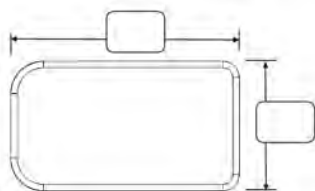

RIGHT

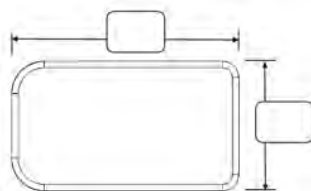

## Pad Modifications Ea.

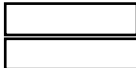
<input type="checkbox"/>	71068	Modification Extra Foam	\$ 26	
		<input type="checkbox"/> XX-Soft		
		<input type="checkbox"/> X-Soft		
		<input type="checkbox"/> Soft		
		<input type="checkbox"/> Medium		
<input type="checkbox"/>	71067	Modification add Gel 1/4"	\$ 39	
<input type="checkbox"/>	Set Pad FLUSH with Front of Seat		N/C	
<input type="checkbox"/>	Set Pad BACK from Front Edge <i>Indicate distance in Box at right</i>		N/C	Distance 
<input type="checkbox"/>	Set Pad BEYOND of Front Edge <i>Indicate distance in Box at right</i>		N/C	

## Front Hip Pad Fabric Color and Type N/C

Contact

Non-Contact

## Spacers (1/2" Each) Each K0108

LEFT		RIGHT	
Qty		Qty	
	50098		50098 Spacer (1/2") \$ 25

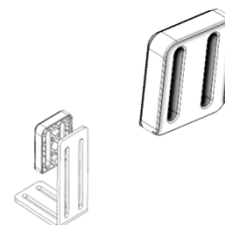

## Fixed Bracket Each E0956

LEFT

RIGHT



## Adjustable Angle Bracket Each E0956

LEFT

RIGHT

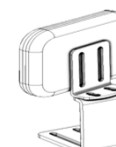

**Removable Bracket (Non-Locking) Each E1028**

**LEFT**

**RIGHT**



**Flip Down Bracket Each E1028**

**LEFT**

**RIGHT**

- |                                |                                |                       |        |
|--------------------------------|--------------------------------|-----------------------|--------|
| <input type="checkbox"/> 31397 | <input type="checkbox"/> 31397 | Flip Down for Quantum | \$ 161 |
|--------------------------------|--------------------------------|-----------------------|--------|

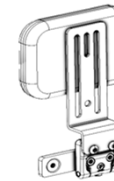

**Medial Thigh Supports**

**Flipdown Hardware Kits w/Pad Only (no cover) E0957 and E1028**

- |                          |        |  |        |
|--------------------------|--------|--|--------|
| <input type="checkbox"/> | 31495L | Abductor Flip-Down w/ Large Molded Pad | \$ 257 |
| <input type="checkbox"/> | 31495M | Abductor Flip-Down w/Medium Molded Pad | \$ 257 |
| <input type="checkbox"/> | 31495P | Abductor Flip-Down w/ Narrow Gel Pad   | \$ 289 |
| <input type="checkbox"/> | 31495S | Abductor Flip-Down w/ Small Molded Pad | \$ 257 |



**Flipdown Bracket (no Pad) E1028**

- |                          |       |   |        |
|--------------------------|-------|---|--------|
| <input type="checkbox"/> | 50180 | Abductor Hardware, Stainless Steel Flip-Dow | \$ 185 |
|--------------------------|-------|---|--------|

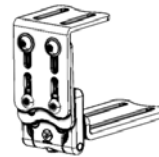

**Heavy Duty Flipdown Bracket E1028**

- |                          |       |   |        |
|--------------------------|-------|---|--------|
| <input type="checkbox"/> | 50700 | Narrow Flip-Down for 1-5/8" to 3" Thick Sea | \$ 282 |
| <input type="checkbox"/> | 50701 | Narrow Flip-Down for 3" to 4-1/4" Thick Sea | \$ 282 |
| <input type="checkbox"/> | 50702 | Narrow Flip-Down for 4" to 5-1/2" Thick Sea | \$ 282 |



**Medial Thigh Pads E0957**

**Pad with Cover**

- |                          |       |                              |        |
|--------------------------|-------|------------------------------|--------|
| <input type="checkbox"/> | 50285 | Pad, Molded w/ Cover, Small  | \$ 144 |
| <input type="checkbox"/> | 50286 | Pad, Molded w/ Cover, Medium | \$ 144 |
| <input type="checkbox"/> | 50287 | Pad, Molded w/ Cover, Large  | \$ 145 |

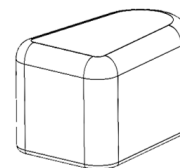

**Pad without Cover**

- |                          |       |                              |       |
|--------------------------|-------|------------------------------|-------|
| <input type="checkbox"/> | 31429 | Abductor Pad, Molded, Small  | \$ 92 |
| <input type="checkbox"/> | 31430 | Abductor Pad, Molded, Medium | \$ 92 |
| <input type="checkbox"/> | 31431 | Abductor Pad, Molded, Large  | \$ 92 |

**Gel Pads**

- |                          |       |  |        |
|--------------------------|-------|--|--------|
| <input type="checkbox"/> | 50288 | Abductor Pad, Narrow Molded Gel w/ Remov | \$ 155 |
|--------------------------|-------|--|--------|

**Custom Pad**

- |                          |       |                     |        |
|--------------------------|-------|---------------------|--------|
| <input type="checkbox"/> | 50037 | Custom Abductor Pad | \$ 397 |
|--------------------------|-------|---------------------|--------|

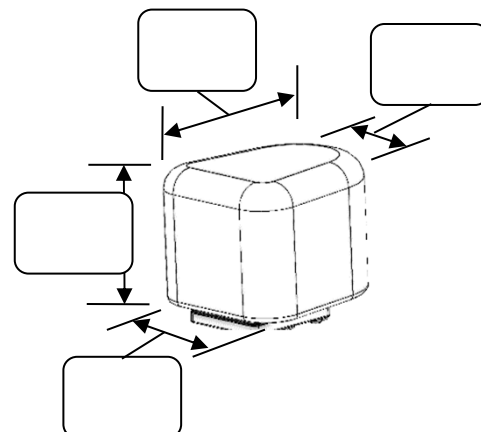

## Lateral Knee Supports

### Muti-Axis Knee Adductor and Pad Each K0108

7/8" Tubing	<input type="checkbox"/>	31547	7/8" Mount, Small Pad, Each	\$255.00
	<input type="checkbox"/>	31548	7/8" Mount, Medium Pad, Each	\$255.00
	<input type="checkbox"/>	31549	7/8" Mount, Large Pad, Each	\$255.00
1" Tubing	<input type="checkbox"/>	31532	1" Mount, Small Pad, Each	\$255.00
	<input type="checkbox"/>	31533	1" Mount, Medium Pad, Each	\$255.00
	<input type="checkbox"/>	31534	1" Mount, Large Pad, Each	\$255.00

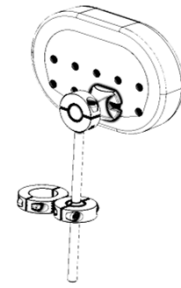

### Muti-Axis Knee Adductor and Pad Pair K0108

7/8" Tubing	<input type="checkbox"/>	50277	7/8" Mount, Small Pad, Pair	\$507.00
	<input type="checkbox"/>	50278	7/8" Mount, Medium Pad, Pair	\$507.00
	<input type="checkbox"/>	50279	7/8" Mount, Large Pad, Pair	\$507.00
1" Tubing	<input type="checkbox"/>	50280	1" Mount, Small Pad, Pair	\$507.00
	<input type="checkbox"/>	50281	1" Mount, Medium Pad, Pair	\$507.00
	<input type="checkbox"/>	50282	1" Mount, Large Pad, Pair	\$507.00

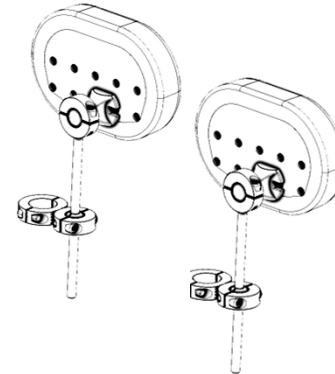

### Flip Down Knee Adductor w/Short Arm E1028 (order pad below)

3/4" OR 7/8" OR 1" Tubing	<input type="checkbox"/>	30271	Short Arm for 3/4" OR 7/8" OR 1" Tubing, Left	\$306.00
	<input type="checkbox"/>	30272	Short Arm for 3/4" OR 7/8" OR 1" Tubing, Right	\$306.00
	<input type="checkbox"/>	30248	Short Arm for 3/4" OR 7/8" OR 1" Tubing, Pair	\$610.00
1 1/8" Tubing	<input type="checkbox"/>	32979	Short Arm for 1.125" Tubing, Left	\$355.00
	<input type="checkbox"/>	32980	Short Arm for 1.125" Tubing, Right	\$355.00
	<input type="checkbox"/>	32982	Short Arm for 1.125" Tubing, Pair	\$710.00
1 1/4" Tubing	<input type="checkbox"/>	30092	Short Arm for 1.25" Tubing, Left	\$355.00
	<input type="checkbox"/>	30093	Short Arm for 1.25" Tubing, Right	\$355.00
	<input type="checkbox"/>	30083	Short Arm for 1.25" Tubing, Pair	\$710.00
1 3/8" Tubing	<input type="checkbox"/>	32971	Short Arm for 1.375" Tubing, Left	\$366.00
	<input type="checkbox"/>	32972	Short Arm for 1.375" Tubing, Right	\$366.00
	<input type="checkbox"/>	32974	Short Arm for 1.375" Tubing, Par	\$731.00
Quantu m Tracks	<input type="checkbox"/>	30255	Short Arm for Quantum Channel, Left	\$306.00
	<input type="checkbox"/>	30256	Short Arm for Quantum Channel, Right	\$306.00
	<input type="checkbox"/>	30240	Short Arm for Quantum Channel, Pair	\$610.00

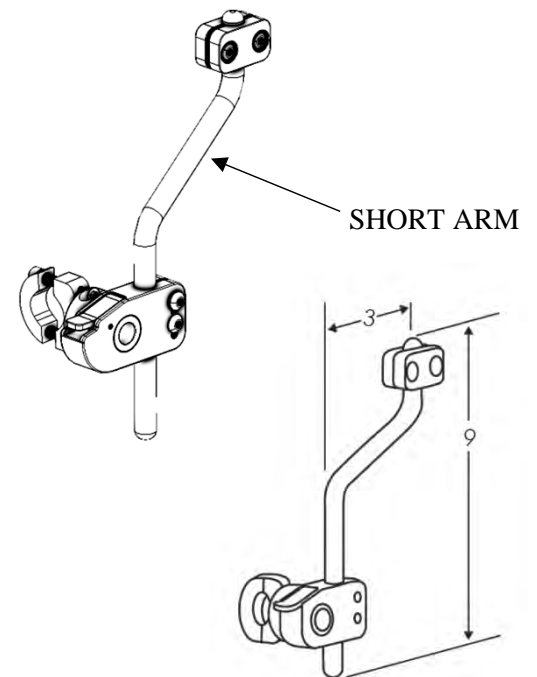

### Flip Down Knee Adductor w/Long Arm E1028 (order pad below)

3/4" OR 7/8" OR 1" Tubing	<input type="checkbox"/>	30079	Long Arm for 3/4" OR 7/8" OR 1" Tubing, Left	\$306.00
	<input type="checkbox"/>	30080	Long Arm for 3/4" OR 7/8" OR 1" Tubing, Right	\$306.00
	<input type="checkbox"/>	30284	Long Arm for 3/4" OR 7/8" OR 1" Tubing, Pair	\$610.00
1 1/8" Tubing	<input type="checkbox"/>	32977	Long Arm for 1.125" Tubing, Left	\$355.00
	<input type="checkbox"/>	32978	Long Arm for 1.125" Tubing, Right	\$355.00
	<input type="checkbox"/>	32981	Long Arm for 1.125" Tubing, Pair	\$710.00
1 1/4" Tubing	<input type="checkbox"/>	30090	Long Arm for 1.25" Tubing, Left	\$355.00
	<input type="checkbox"/>	30091	Long Arm for 1.25" Tubing, Right	\$355.00
	<input type="checkbox"/>	30082	Long Arm for 1.25" Tubing, Pair	\$710.00
1 3/8" Tubing	<input type="checkbox"/>	32969	Long Arm for 1.375" Tubing, Left	\$366.00
	<input type="checkbox"/>	32970	Long Arm for 1.375" Tubing, Right	\$366.00
	<input type="checkbox"/>	32973	Long Arm for 1.375" Tubing, Par	\$731.00
Quantum Tracks	<input type="checkbox"/>	30291	Long Arm for Quantum Channel, Left	\$306.00
	<input type="checkbox"/>	30292	Long Arm for Quantum Channel, Right	\$306.00
	<input type="checkbox"/>	30276	Long Arm for Quantum Channel, Pair	\$610.00

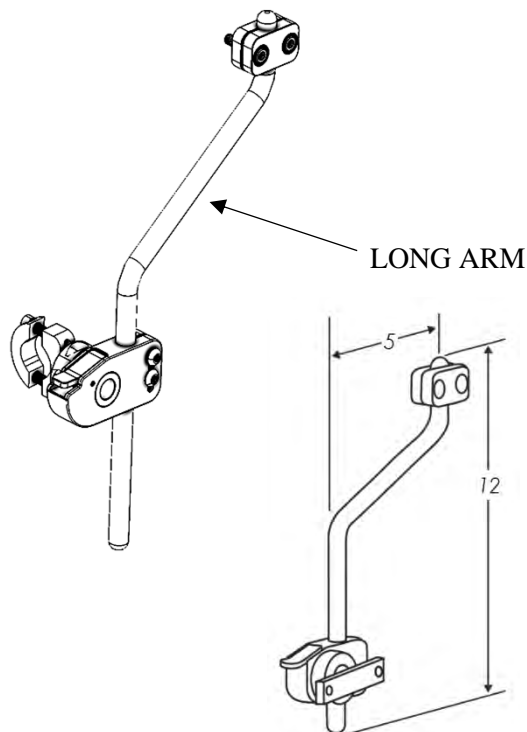

### Lateral Knee Pads E0957

Qty		<b>Pad with Neoprene Cover Ea</b>	
<input type="checkbox"/>	50490	Knee Adductor Pad w/ Neoprene Cover, 3x4	\$119.00
<input type="checkbox"/>	50491	Knee Adductor Pad w/ Neoprene Cover, 4x6	\$119.00
<input type="checkbox"/>	50492	Knee Adductor Pad w/ Neoprene Cover, 5x7	\$119.00

Qty		<b>Pad without Cover Ea</b>	
<input type="checkbox"/>	31460S	Knee Adductor Pad, 3x4	\$ 74.00
<input type="checkbox"/>	31460M	Knee Adductor Pad, 4x6	\$ 74.00
<input type="checkbox"/>	31460L	Knee Adductor Pad, 5x7	\$ 78.00

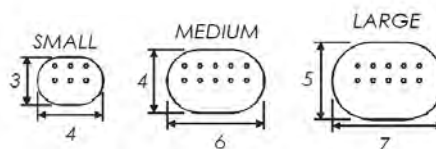
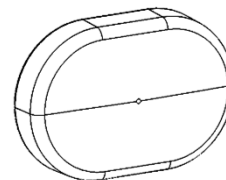

### Lateral Knee Pads Covers K0108

Qty		<b>Cover with Gel Insert</b>	
<input type="checkbox"/>	50048	Cover w/ Gel Insert, Small	\$128.00
<input type="checkbox"/>	50049	Cover w/ Gel Insert, Medium	\$128.00
<input type="checkbox"/>	50050	Cover w/ Gel Insert, Large	\$128.00

Qty		<b>Neoprene Cover</b>	
<input type="checkbox"/>	32383	Adductor Pad Cover, Neoprene, Small	\$ 67.00
<input type="checkbox"/>	32384	Adductor Pad Cover, Neoprene, Medium	\$ 67.00
<input type="checkbox"/>	32385	Adductor Pad Cover, Neoprene, Large	\$ 67.00

Qty		<b>Custom Pad E0955 Each</b>	
<input type="checkbox"/>	50493	Custom Abductor Pad	\$194.00

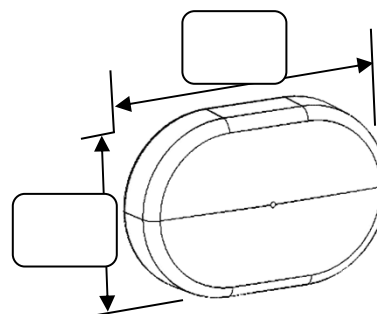

## **TheraFit 4 Point Hip Belt**

**1" Straps, 4.25L x 1.75H Pads E0978**

**1" Straps, 5.25L x 1.75H Pads E0978**

**1.5" Straps, 5.25L x 2.25H Pads E0978**

**1.5" Straps, 7.25L x 2.25H Pads E0978**



## **TheraFit 4 Point Y Style Hip Belt**

**Y-Style Pads, 1" Straps, 6" long Pads E0978**

**Y-Style Pads, 1.5" Straps, 9" long Pads E0978**

**Y-Style Pads, 2" Straps, 11" long Pads E0978**



## **TheraFit Single Pull Hip Belt**

***PUSH BUTTON BUCKLE***

**Single Pull 1" Straps, 4.25L x 1.75H Pads E0978**

**Single Pull 1" Straps, 5.25L x 1.75H Pads E0978**

**Single Pull 1" Straps, 6.25L x 1.75H Pads E0978**

**Single Pull 1.5" Straps, 5.25L x 2.25H Pads E0978**

**Single Pull 1.5" Straps, 7.25L x 2.25H Pads E0978**

**Single Pull 1.5" Straps, 9.25L x 2.25H Pads E0978**

**Single Pull 2" Straps, 9.25L x 3H Pads E0978**

**Single Pull 2" Straps, 11.25L x 3H Pads E0978**

**Bariatric Single Pull 2" Straps, 11.25L x 3H Pads E0978**

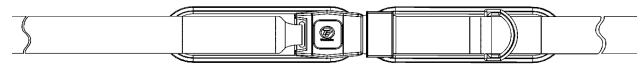

**TheraFit Single Pull Hip Belt**

*SECURITY STYLE BUCKLE*

Single Pull 1" Straps, 4.25L x 1.75H Pads E0978

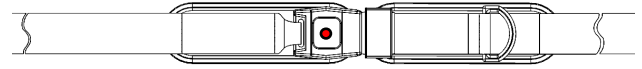

Single Pull 1" Straps, 5.25L x 1.75H Pads E0978



METAL CLIP



CAM LOCK  
BUCKLE

Single Pull 1" Straps, 6.25L x 1.75H Pads E0978

Single Pull 1.5" Straps, 5.25L x 2.25H Pads E0978

Single Pull 1.5" Straps, 7.25L x 2.25H Pads E0978

Single Pull 1.5" Straps, 9.25L x 2.25H Pads E0978

Single Pull 2" Straps, 9.25L x 3H Pads E0978

Single Pull 2" Straps, 11.25L x 3H Pads E0978

**TheraFit Single Pull Hip Belt**

*SIDE RELEASE STYLE BUCKLE*

Single Pull 1" Straps, 4.25L x 1.75H Pads E0978

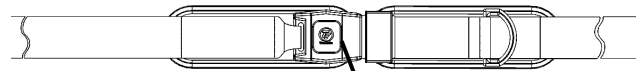

PLASTIC



METAL CLIP



CAM LOCK  
BUCKLE

Single Pull 1" Straps, 5.25L x 1.75H Pads E0978

Single Pull 1" Straps, 6.25L x 1.75H Pads E0978

Single Pull 1.5" Straps, 5.25L x 2.25H Pads E0978

Single Pull 1.5" Straps, 7.25L x 2.25H Pads E0978

Single Pull 1.5" Straps, 9.25L x 2.25H Pads E0978

Single Pull 2" Straps, 9.25L x 3H Pads E0978

Single Pull 2" Straps, 11.25L x 3H Pads E0978



## TheraFit Single Pull Unpadded Hi

### *PUSH BUTTON BUCKLE*

#### Single Pull 1" Straps, Unpadded E0978

- 33120 Belt w/Clips \$ 48.00

#### Single Pull 1.5" Straps, Unpadded E0978

- 33130 Belt w/Clips AND Cams \$ 48.00

#### Single Pull 2" Straps, Unpadded E0978

- 33140 Belt w/Clips AND Cams \$ 48.00

- 33148 Extra Long 80" Long Belt w/Clips \$ 54.00

### *SECURITY STYLE BUCKLE*

#### Single Pull 1" Straps, Unpadded E0978

- 33126 Belt w/Clips \$ 62.00

#### Single Pull 1.5" Straps, Unpadded E0978

- 60310 Belt w/Clips AND Cams \$ 62.00

#### Single Pull 2" Straps, Unpadded E0978

- 33146 Belt w/Clips AND Cams \$ 62.00

### *SIDE RELEASE STYLE BUCKLE*

#### Single Pull 1" Straps, Unpadded E0978

- 33127 Belt w/Clips \$ 45.00

#### Single Pull 1.5" Straps, Unpadded E0978

- 33136 Belt w/Clips AND Cams \$ 45.00

#### Single Pull 2" Straps, Unpadded E0978

- 33147 Belt w/Clips AND Cams \$ 45.00

### *METAL FLAP (AIRPLANE) STYLE BUCKLE*

#### Single Pull 2" Straps, Unpadded E0978

- 33149 Belt w/Clips \$ 81.00

### *PUSH BUTTON BUCKLE*

#### Push Button (Travis Logo) Single Pull 1.5" Straps, Unpadded E0978

- 60129 Belt w/Clips \$ 48.00

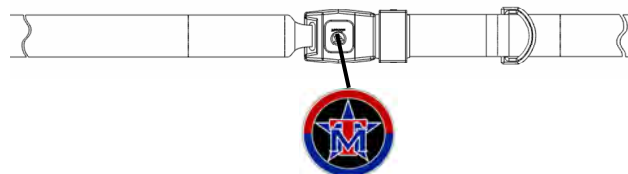
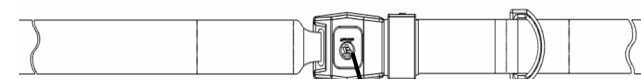

## TheraFit Slip on Pads

K0108



## TheraFit Rear Pull Hip Belt

### *PUSH BUTTON BUCKLE*

#### Single Pull 1" Straps, 6.25L x 1.75H Pads E0978

<input type="checkbox"/>	60161 Belt w/Clips	\$ 94.00
<input type="checkbox"/>	60162 Belt w/Cams	\$ 94.00
<input type="checkbox"/>	60163 Belt w/Clips AND Cams	\$ 96.00

#### Single Pull 1.5" Straps, 7.25L x 2.25H Pads E0978

<input type="checkbox"/>	60171 Belt w/Clips	\$102.00
<input type="checkbox"/>	60172 Belt w/Cams	\$115.00
<input type="checkbox"/>	60173 Belt w/Clips AND Cams	\$119.00

#### Single Pull 1.5" Straps, 9.25L x 2.5H Pads E0978

<input type="checkbox"/>	60181 Belt w/Clips	\$102.00
<input type="checkbox"/>	60182 Belt w/Cams	\$115.00
<input type="checkbox"/>	60183 Belt w/Clips AND Cams	\$119.00

### *SECURITY STYLE BUCKLE*

#### Single Pull 1" Straps, 6.25L x 1.75H Pads E0978

<input type="checkbox"/>	60311 Belt w/Clips	\$104.00
<input type="checkbox"/>	60312 Belt w/Cams	\$104.00
<input type="checkbox"/>	60313 Belt w/Clips AND Cams	\$106.00

#### Single Pull 1.5" Straps, 7.25L x 2.25H Pads E0978

<input type="checkbox"/>	60321 Belt w/Clips	\$113.00
<input type="checkbox"/>	60322 Belt w/Cams	\$126.00
<input type="checkbox"/>	60323 Belt w/Clips AND Cams	\$130.00

#### Single Pull 1.5" Straps, 9.25L x 2.5H Pads E0978

<input type="checkbox"/>	60331 Belt w/Clips	\$113.00
<input type="checkbox"/>	60332 Belt w/Cams	\$126.00
<input type="checkbox"/>	60333 Belt w/Clips AND Cams	\$130.00

## TheraFit Center Pull Hip Belt

### *SIDE RELEASE STYLE BUCKLE*

#### Center Pull 1" Straps, 4.25L x 1.75H Pads E0978

#### Center Pull 1" Straps, 5.25L x 1.75H Pads E0978

#### Center Pull 1.5" Straps, 5.25L x 2.25H Pads E0978

#### Center Pull 1.5" Straps, 7.25L x 2.25H Pads E0978

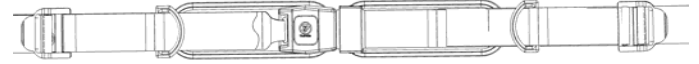

METAL CLIP



CAM LOCK BUCKLE

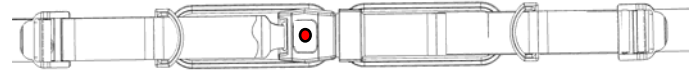

METAL CLIP



CAM LOCK BUCKLE



## Hip Belt Accessories

### Hip Belt Extender Straps K0108

<input type="checkbox"/>	60144 Belt Extender Straps, 1" Pair	\$ 41.00
<input type="checkbox"/>	60145 Belt Extender Straps, 1.5" Pair	\$ 41.00
<input type="checkbox"/>	60146 Belt Extender Straps, 2" Pair	\$ 41.00

### BELT EXTENDER STRAPS, EACH 24" LONG



### Hinged Collar K0108

50410 Collar, Hinged - 7/8", 1" & 1-1/8" Diameter \$ 22.00

\_\_\_\_\_ (Insert quantity)

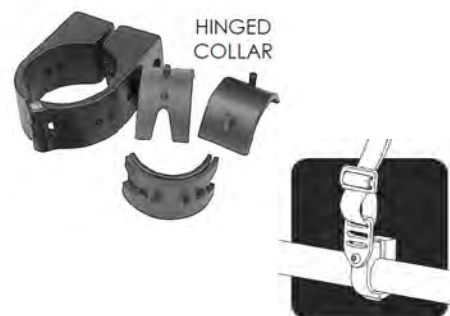

## Seat Harness

### STATIC SEAT HARNESS

#### Static Front Pull

<input type="checkbox"/>	50726 Small	\$192.00
<input type="checkbox"/>	50727 Medium	\$192.00
<input type="checkbox"/>	50728 Large	\$192.00

#### Static Rear Pull

<input type="checkbox"/>	50729 Small	\$192.00
<input type="checkbox"/>	50730 Medium	\$192.00
<input type="checkbox"/>	50731 Large	\$192.00

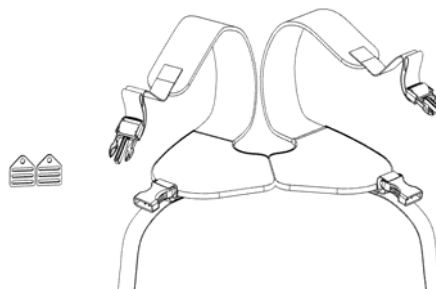

### LEGACY (STRETCH) SEAT HARNESS

#### Stretch Harness

<input type="checkbox"/>	30516 Small	\$186.00
<input type="checkbox"/>	30517 Medium	\$186.00
<input type="checkbox"/>	30518 Large	\$186.00



# TheraFit Shoulder Harness

## Shoulder Harness with Clips E0960

- 61301 Shoulder Harness, TheraFit, X-Small w/ Clip \$ 156
- 61401 Shoulder Harness, TheraFit, Small w/ Clips \$ 151
- 61501 Shoulder Harness, TheraFit, Medium w/ Clip \$ 157
- 61701 Shoulder Harness, TheraFit, Large w/ Clips \$ 164
- 61801 Shoulder Harness, TheraFit, X-Large w/ Clip \$ 171

## Shoulder Harness with Camlocks E0960

- 61302 Shoulder Harness, TheraFit, X-Small w/ Can \$ 156
- 61402 Shoulder Harness, TheraFit, Small w/ Camlo \$ 151
- 61502 Shoulder Harness, TheraFit, Medium w/ Can \$ 157
- 61702 Shoulder Harness, TheraFit, Large w/ Camlo \$ 164
- 61802 Shoulder Harness, TheraFit, X-Large w/ Can \$ 171

## Shoulder Harness with Clips and Camlocks E0960

- 61303 Shoulder Harness, TheraFit, X-Small w/ Clip \$ 156
- 61403 Shoulder Harness, TheraFit, Small w/ Clips & \$ 151
- 61503 Shoulder Harness, TheraFit, Medium w/ Clip \$ 157
- 61703 Shoulder Harness, TheraFit, Large w/ Clips & \$ 164
- 61803 Shoulder Harness, TheraFit, X-Large w/ Clip \$ 171

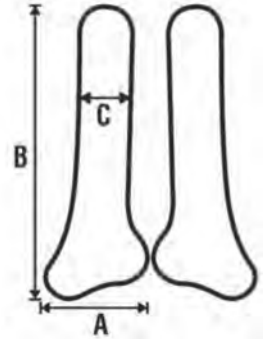
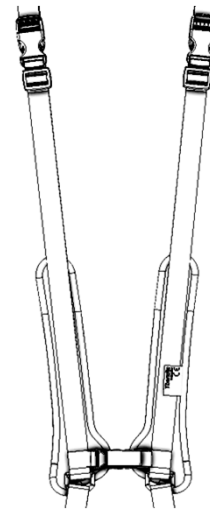

Harness Dimensions (inches)	A	B	C
X-SMALL	2.7	8.6	1.4
SMALL	3.0	12.0	1.8
MEDIUM	3.4	13.4	2.0
LARGE	4.0	16.1	2.3
X-LARGE	4.5	18.2	2.6

## Stretch TheraFit Vest

### Full Shape with Comfort Fit Straps E0960

- 30589 Vest, Full, Small \$ 161
- 30590 Vest, Full, Medium \$ 161
- 30591 Vest, Full, Large \$ 161
- 30592 Vest, Full, X-Large \$ 161
- 30593 Vest, Full, 2X-Large \$ 169

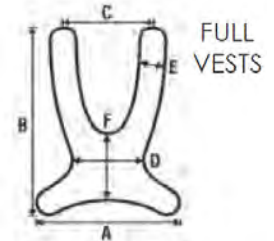

Vest Dimensions (inches)	A	B	C	D	E	F
Full SMALL	9.5	12.5	5.5	5	2	5
Full MEDIUM	11.25	15	7	5.75	2	5.5
Full LARGE	13.5	18	8.5	7	2.5	6.5
Full X-LARGE	15.75	21	10	8	3	7.5
Full 2X-LARGE	18	24	11	9.25	3.5	8.5

### Trim Shape with Comfort Fit Straps E0960

- 30601 Vest, Trim, Early Intervention \$ 163
- 30618 Vest, Trim, Small \$ 163
- 30619 Vest, Trim, Medium \$ 163
- 30620 Vest, Trim, Large \$ 163
- 30621 Vest, Trim, X-Large \$ 169
- 30622 Vest, Trim, 2X-Large \$ 169

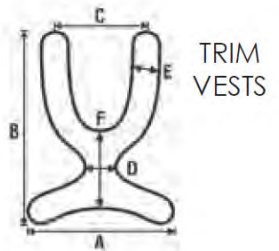
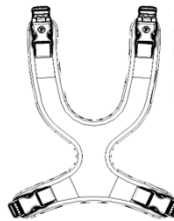

Vest Dimensions (inches)	A	B	C	D	E	F
Trim EARLY INTERVENTION	7.25	10.5	6.25	1	1.5	4
Trim SMALL	9.5	12.5	6	2	2	5.5
Trim MEDIUM	11.25	15	7	2.5	2	6
Trim LARGE	13.5	18	8.5	3	2.5	7.25
Trim X-LARGE	15.75	21	10	3.5	3	8.5
Trim 2X-LARGE	18	24	11	4.25	3.5	9.5

### Full Shape with Extended Straps Straps E0960

- 30594 Vest, Full, Small \$ 161
- 30595 Vest, Full, Medium \$ 161
- 30596 Vest, Full, Large \$ 161
- 30597 Vest, Full, X-Large \$ 169
- 30598 Vest, Full, 2X-Large \$ 169



### Trim Shape with Comfort Fit Straps E0960

- 30603 Vest, Trim, Early Intervention \$ 163
- 30604 Vest, Trim, Small \$ 163
- 30624 Vest, Trim, Medium \$ 163
- 30625 Vest, Trim, Large \$ 163
- 30626 Vest, Trim, X-Large \$ 169
- 30627 Vest, Trim, 2X-Large \$ 169

## Non-Stretch Legacy Vest

### Full Shape with No-Sew Buckles (Comfort Fit) E0960

<input type="checkbox"/>	30479 Static,w/ No-Sew Buckles, Full, Small	\$ 166
<input type="checkbox"/>	30480 Static w/ No-Sew Buckles, Full, Medium	\$ 166
<input type="checkbox"/>	30481 Static w/ No-Sew Buckles, Male, Large	\$ 166
<input type="checkbox"/>	30507 Static w/ No-Sew Buckles, Male, X-Large	\$ 166

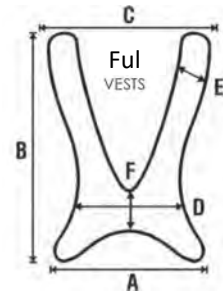

### Trim Shape with No-Sew Buckles (Comfort Fit) E09

<input type="checkbox"/>	30482 Static w/ No-Sew Buckles, Trim, Small	\$ 166
<input type="checkbox"/>	30483 Static w/ No-Sew Buckles, Trim, Medium	\$ 166
<input type="checkbox"/>	30484 Static w/ No-Sew Buckles, Trim, Large	\$ 166

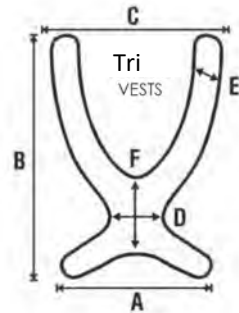

### Full Shape with Extended Straps E0960

<input type="checkbox"/>	51044 Static w/ Extended Straps, Full, X-Small	\$ 166
<input type="checkbox"/>	51045 Static w/ Extended Straps, Full, Small	\$ 166
<input type="checkbox"/>	51046 Static w/ Extended Straps, Full, Medium	\$ 166
<input type="checkbox"/>	51047 Static w/ Extended Straps, Full, Large	\$ 166
<input type="checkbox"/>	51048 Static w/ Extended Straps, Full, X-Large	\$ 166



Stretch & Non-Stretch Vests						
Vest Dimensions (inches)	A	B	C	D	E	F
Male X-SMALL	5.5	7.5	7.5	4.75	1.5	3.5
Male SMALL	7	12	8	5.5	1.75	2.75
Male MEDIUM	8.25	14	9.75	6.5	2.25	3
Male LARGE	8.75	17.25	12.5	6.75	2.5	5.25
Male X-LARGE	11	21.75	13	7.5	3	7
Female SMALL	7	11	8	2	2	5.25
Female MEDIUM	8	12.5	8	2	2	5.75
Female LARGE	8	16	10	2	2.25	7.5

### Trim Shape with Extended Straps E0960

<input type="checkbox"/>	51049 Static w/ Extended Straps, Trim, Small	\$ 166
<input type="checkbox"/>	51050 Static w/ Extended Straps, Trim, Medium	\$ 166
<input type="checkbox"/>	51051 Static w/ Extended Straps, Trim, Large	\$ 166

## TheraFit Zipper Vest

### Full Shape, Structured (Non-Stretch) E0960

<input type="checkbox"/>	30771 Structured, Zip-Up, Full, Small	\$ 177
<input type="checkbox"/>	30772 Structured, Zip-Up, Full, Medium	\$ 177
<input type="checkbox"/>	30773 Structured, Zip-Up, Full, Large	\$ 177

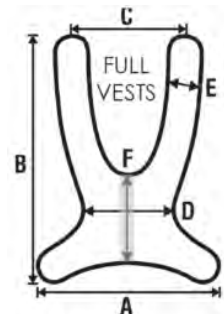
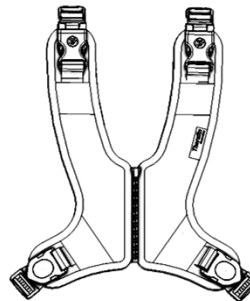

### Full Shape, Stretch (Non-Stretch) E0960

<input type="checkbox"/>	30777 Stretch, Zip-Up, Full, Small	\$ 177
<input type="checkbox"/>	30778 Stretch, Zip-Up, Full, Medium	\$ 177
<input type="checkbox"/>	30779 Stretch Zip-Up, Full, Large	\$ 177

Vest Dimensions (Inches)	A	B	C	D	E	F
Full SMALL	10.5	14	6.5	6	2	5.25
Full MEDIUM	12	16.25	7.5	6.5	2	6.5
Full LARGE	15.5	18.5	9.25	7.5	2.5	6.75

### Trim Shape, Structured (Non-Stretch) E0960

<input type="checkbox"/>	30774 Structured, Zip-Up, Trim, Small	\$ 177
<input type="checkbox"/>	30775 Structured, Zip-Up, Trim, Medium	\$ 177
<input type="checkbox"/>	30776 Structured, Zip-Up, Trim, Large	\$ 177

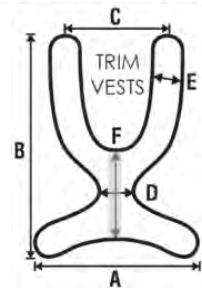
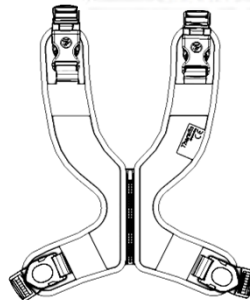

### Trim Shape, Stretch (Non-Stretch) E0960

<input type="checkbox"/>	30780 Stretch, Zip-Up, Trim, Small	\$ 177
<input type="checkbox"/>	30781 Stretch Zip-Up, Trim, Medium	\$ 177
<input type="checkbox"/>	30782 Stretch, Zip-Up, Trim, Large	\$ 177

Vest Dimensions (Inches)	A	B	C	D	E	F
Trim SMALL	10.5	14	6.25	3.5	2	5.25
Trim MEDIUM	12	16.25	7.25	3.5	2	6.5
Trim LARGE	15.5	18.5	9	3.75	2.5	6.75

## TheraFit Y Harness

### Y Harness E0960

<input type="checkbox"/>	30683 Small	\$ 181
<input type="checkbox"/>	30684 Medium	\$ 188
<input type="checkbox"/>	30685 Large	\$ 196

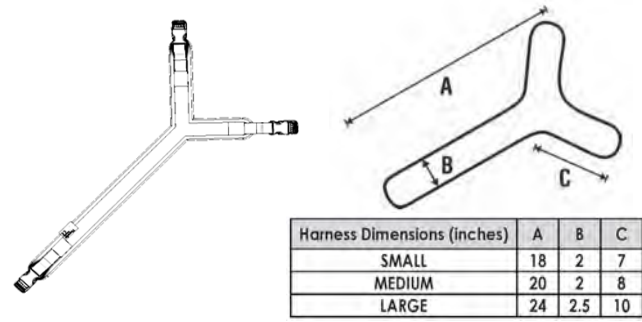

## TheraFit X Harness

### X Harness E0960

<input type="checkbox"/>	30519 Small	\$ 175
<input type="checkbox"/>	30520 Medium	\$ 175
<input type="checkbox"/>	30521 Large	\$ 187

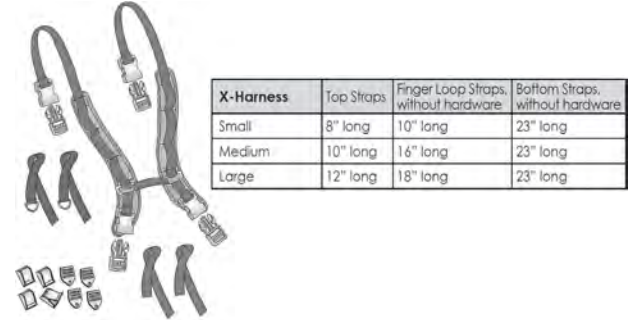

## TheraFit Chest Straps

### 2 Buckles w/Adj. Straps (Stretch) E0960

<input type="checkbox"/>	60110 Dynamic w/ Dual D-Ring Adj, Small	\$ 105
<input type="checkbox"/>	60111 Dynamic w/ Dual D-Ring Adj, Medium	\$ 105
<input type="checkbox"/>	60112 Dynamic w/ Dual D-Ring Adj, Large	\$ 105



Size	Pad Size
Small	3x16
Medium	4x20
Large	4x24

### 1 Buckles w/Adj. Strap (Stretch) E0960

<input type="checkbox"/>	60113 Dynamic w/ Single D-Ring Adj, Small	\$ 134
<input type="checkbox"/>	60114 Dynamic w/ Single D-Ring Adj, Medium	\$ 134
<input type="checkbox"/>	60115 Dynamic w/ Single D-Ring Adj, Large	\$ 134
<input type="checkbox"/>	60123 Dynamic w/ Single D-Ring Adj, X-Large	\$ 156
<input type="checkbox"/>	60124 Dynamic w/ Single D-Ring Adj, 2X-Large	\$ 167



Size	Pad Size
Small	3x16
Medium	4x20
Large	4x24
X-Large	6x28
2X-Large	8x32

### One-Piece w/2 Sewn Straps (Stretch) E0960

<input type="checkbox"/>	60116 Dynamic w/ Fixed Straps, Small	\$ 97
<input type="checkbox"/>	60117 Dynamic w/ Fixed Straps, Medium	\$ 97
<input type="checkbox"/>	60118 Dynamic w/ Fixed Straps, Large	\$ 97



Size	Pad Size
Small	3x16
Medium	4x20
Large	4x24

### Non-Stretch

<input type="checkbox"/>	60147 Static w/ Fixed Straps, Small	\$ 97
<input type="checkbox"/>	60148 Static w/ Fixed Straps, Medium	\$ 97
<input type="checkbox"/>	60149 Static w/ Fixed Straps, Large	\$ 97

### Two-Piece w/2 Sewn Straps (Stretch) E0960

<input type="checkbox"/>	60119 Dynamic w/ Hook-N-Loop Adj, Small	\$ 134
<input type="checkbox"/>	60120 Dynamic w/ Hook-N-Loop Adj, Medium	\$ 134
<input type="checkbox"/>	60121 Dynamic w/ Hook-N-Loop Adj, Large	\$ 134



### Non-Stretch

<input type="checkbox"/>	60150 Static, 2-Piece w/ Hook-N-Loop Adj, Small	\$ 134
<input type="checkbox"/>	60151 Static, 2-Piece w/ Hook-N-Loop Adj, Medium	\$ 134
<input type="checkbox"/>	60152 Static, 2-Piece w/ Hook-N-Loop Adj, Large	\$ 134

Size	Pad Size
Small	3x10 (each piece)
Medium	4x14 (each piece)
Large	4x18 (each piece)

**Two-Piece w/ 2 Sewn Straps, Safety Strap (Non-Stretch) E0960**

- 60153 Static, 2-Piece w/ H&L Adj, 1" Safety Strap, \$ 134
- 60154 Static, 2-Piece w/ H&L Adj, 1" Safety Strap, \$ 134
- 60155 Static, 2-Piece w/ H&L Adj, 1" Safety Strap, \$ 134

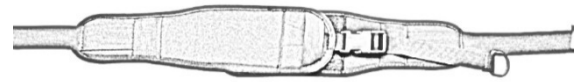

Size	Pad Size
Small	3x10 (each piece)
Medium	4x14 (each piece)
Large	4x18 (each piece)

**1 Rear Buckle w/ Adj. Strap, 1 Sewn Str:**

- 60157 Static w/ Single D-Ring Rear Adj, Small \$ 97
- 60158 Static w/ Single D-Ring Rear Adj, Medium \$ 97
- 60159 Static w/ Single D-Ring Rear Adj, Large \$ 97



Size	Pad Size
Small	3x16
Medium	4x20
Large	4x24

**Universal Positioning Strap**

**Positioning Strap, Universal, Stretch E0960**

- 34434 Small, 3W x 56L \$ 65
- 34435 Medium, 4.5W x 56L \$ 70
- 34436 Large, 6W x 56L \$ 75

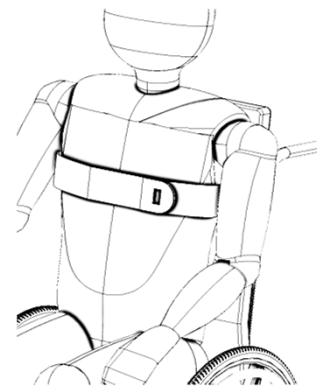

**Strap Guides**

**Strap Positioning Guides, Pair - K0108**

- 51030 Vest Strap Positioning Guides, Pair \$ 34

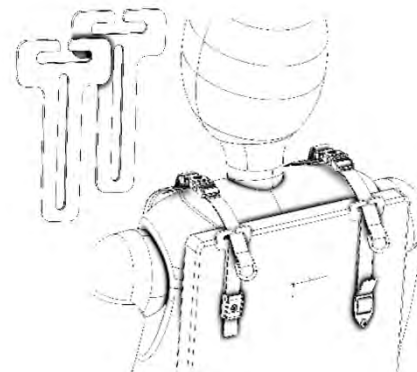

## Foot Supports

Molded Shoe Holder with Padded Straps Pair K0108

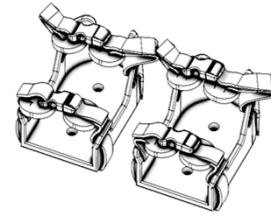

Molded Shoe Holder with Unpadded Straps Pair K0108

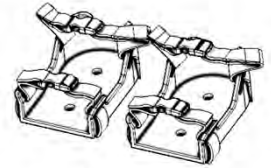

Footsure Ankle Supports with Buckle Pair K0108



Footsure Ankle Supports with Hook and Loop Pair K0108



Flexsure Feet Foot Supports with Buckles Pair K0108



Flexsure Feet Foot Supports with Hook and Loop Pair K0108



Flexsure Padded Inserts Pair K0108

Shoe Sandals with Toe Strap Pair K0108

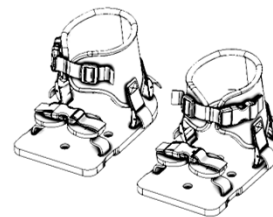

Shoe Sandals with No Toe Strap Pair E0952

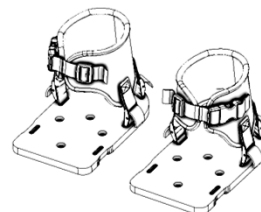

Shoe Sandals Padded Inserts Pair E0952



**2 Piece Padded Shoeholder Pair E0952**

- 30147 Shoeholder w/ 2-Piece Removable 1/2" Thick Pad, 5" x 10", Pair \$284.00

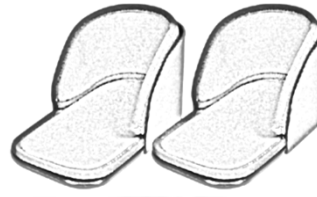

**Padded Full Footbox Each K0108**

- 30111 Footbox, Padded Full, Small \$299.00
- 30112 Footbox, Padded Full, Medium \$321.00
- 30113 Footbox, Padded Full, Large \$321.00

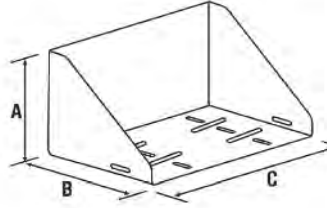

DIMENSIONS (inches)	A	B	C
SMALL	6"	8"	11"
MEDIUM	8"	10"	13"
LARGE	10"	12"	15"

**Padded Split Footbox Pair K0108**

- 30152 Footbox, Padded Split, Small \$399.00
- 30153 Footbox, Padded Split, Medium \$404.00
- 30154 Footbox, Padded Split, Large \$411.00

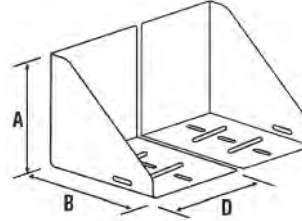

DIMENSIONS (inches)	A	B	D
SMALL	6"	8"	5.5"
MEDIUM	8"	10"	6.5"
LARGE	10"	12"	7.5"

**Custom Padded Full Footbox Each K0108**

- 70043 Footbox, Custom Full w/ Removable Padding \$ 1,363.00

**Box Material**

- 3/8" ABS (Standard)
- Other (Specify)

**Foam Thickness**

- 1/2" (Standard)
- 1"
- Other (Specify)

**Foam Type**

- Poly (Standard)
- Other (Specify)

**Cover Material**

- Soft Vinyl (Standard)
- Other (Specify)

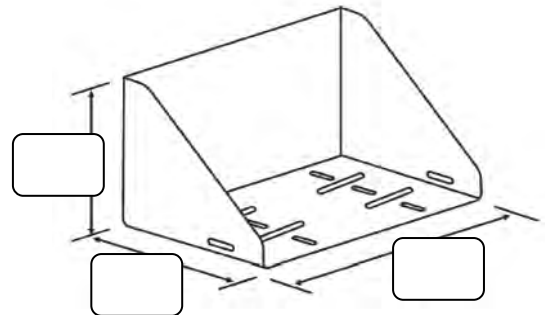

**Custom Padded Split Footbox Pair K0108**

- 70142 Footbox, Custom Split w/ Removable Padding \$ 1,363.00

**Box Material**

- 3/8" ABS (Standard)
- Other (Specify)

**Foam Thickness**

- 1/2" (Standard)
- 1"
- Other (Specify)

**Foam Type**

- Poly (Standard)
- Other (Specify)

**Cover Material**

- Soft Vinyl (Standard)
- Other (Specify)

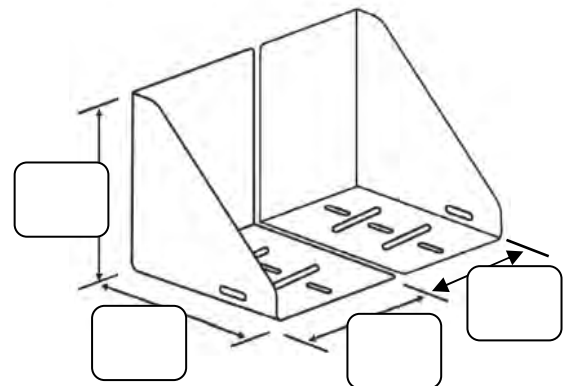

## Toe Straps Pair E0952

### Basic Leg Strap E0960

<input type="checkbox"/>	30398	Leg Strap, Basic, Single	\$ 52.00
<input type="checkbox"/>	30399	Leg Strap, Basic, Pair	\$ 97.00



### Premium Calf Panel K0108

<input type="checkbox"/>	60038	Calf Panel, Premium, Small	\$ 96.00
<input type="checkbox"/>	60039	Calf Panel, Premium, Medium	\$ 96.00
<input type="checkbox"/>	60040	Calf Panel, Premium, Large	\$ 96.00
<input type="checkbox"/>	60044	Calf Panel, Premium, X-Large	\$175.00
<input type="checkbox"/>	60045	Calf Panel, Premium, 2X-Large	\$187.00

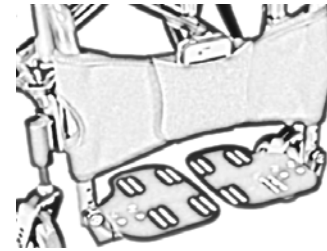

### Pocket for Premium Calf Panel K0108

<input type="checkbox"/>	60041	Calf Panel Convenience Pocket, Small	\$ 30.00
<input type="checkbox"/>	60042	Calf Panel Convenience Pocket, Medium	\$ 30.00
<input type="checkbox"/>	60043	Calf Panel Convenience Pocket, Large	\$ 30.00

### Calf Panel K0108

<input type="checkbox"/>	30485	Calf Panel, Standard, Small 11" x 4"	\$ 70.00
<input type="checkbox"/>	30486	Calf Panel, Standard, Medium 13" x 6"	\$ 70.00
<input type="checkbox"/>	30487	Calf Panel, Standard, Large 15" x 8"	\$ 70.00



### Custom Calf Board K0108

<input type="checkbox"/>	60098	Custom Calf/Leg Board	\$206.00
--------------------------	-------	-----------------------	----------

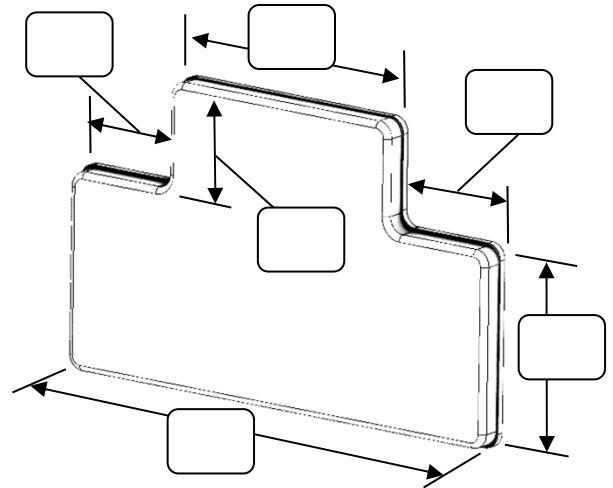

### Custom Foot Plate Board K0108

<input type="checkbox"/>	52701	Custom Foot Plate Pad	\$231.00
--------------------------	-------	-----------------------	----------

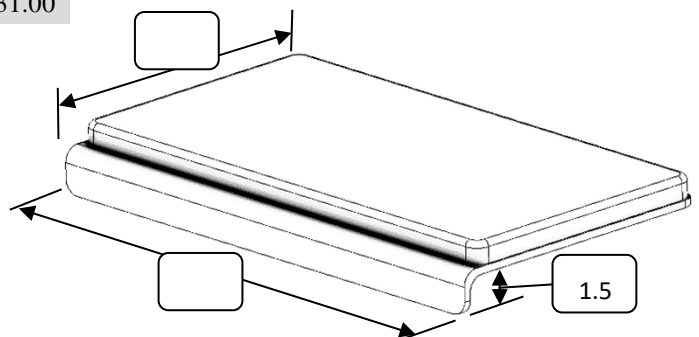

## Arm Troughs

### Arm Trough, Slide-On 4.5"W x 12L

<input type="checkbox"/>	41418	SLIDE-ON, LEFT	\$ 376
<input type="checkbox"/>	41419	SLIDE-ON, RIGHT	\$ 375

Left only Shown

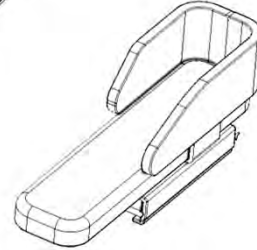
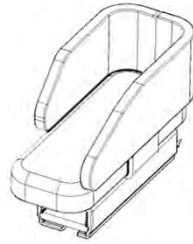

### Arm Trough, Slide-On 4.5"W x 18L

<input type="checkbox"/>	41420	SLIDE-ON, LEFT	\$ 375
<input type="checkbox"/>	41421	SLIDE-ON, RIGHT	\$ 375

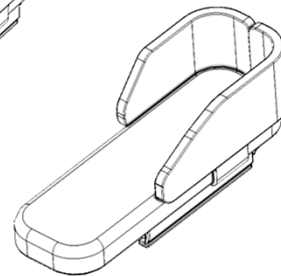
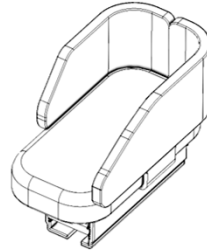

### Arm Trough, Slide-On 6"W x 12L

<input type="checkbox"/>	41422	SLIDE-ON, LEFT	\$ 375
<input type="checkbox"/>	41423	SLIDE-ON, RIGHT	\$ 375

### Arm Trough, Slide-On 6"W x 18L

<input type="checkbox"/>	41424	SLIDE-ON, LEFT	\$ 375
<input type="checkbox"/>	41425	SLIDE-ON, RIGHT	\$ 375

---

### Arm Trough, Clamp-On 4.5"W x 12L

<input type="checkbox"/>	41426	SLIDE-ON, LEFT	\$ 387
<input type="checkbox"/>	41427	SLIDE-ON, RIGHT	\$ 387

Left only Shown

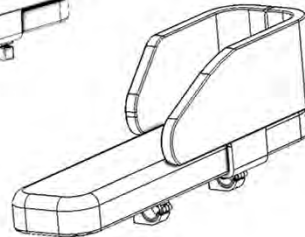
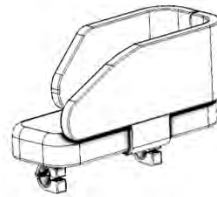

### Arm Trough, Clamp-On 4.5"W x 18L

<input type="checkbox"/>	41428	SLIDE-ON, LEFT	\$ 387
<input type="checkbox"/>	41429	SLIDE-ON, RIGHT	\$ 387

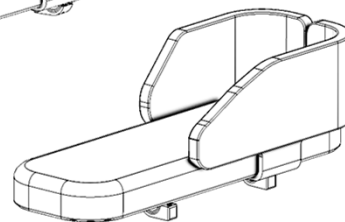
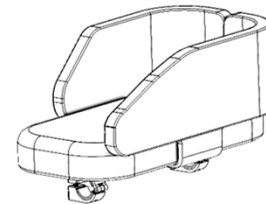

### Arm Trough, Clamp-On 6"W x 12L

<input type="checkbox"/>	41430	SLIDE-ON, LEFT	\$ 387
<input type="checkbox"/>	41431	SLIDE-ON, RIGHT	\$ 387

### Arm Trough, Clamp-On 6"W x 18L

<input type="checkbox"/>	41432	SLIDE-ON, LEFT	\$ 387
<input type="checkbox"/>	41433	SLIDE-ON, RIGHT	\$ 387

## Standard Tray

To Order Standard Tray Place Part Number Below

Refer to Tray Order Form If Needed

## Full Tray Attachment Hardware

(Hardware for trays that attach to both armrests)

### E-Z Lock Clamps

- |                          |       |                      |        |
|--------------------------|-------|----------------------|--------|
| <input type="checkbox"/> | 31098 | E-Z Lock Clamps Pair | \$ 153 |
|--------------------------|-------|----------------------|--------|

### E-Z Lock Clamps - Tube Arms

- |                          |       |                                  |        |
|--------------------------|-------|----------------------------------|--------|
| <input type="checkbox"/> | 31072 | E-Z Lock Clamps - Tube Arms Pair | \$ 163 |
|--------------------------|-------|----------------------------------|--------|

Tray Must be at least 1" wider than outside-to-outside armpad width

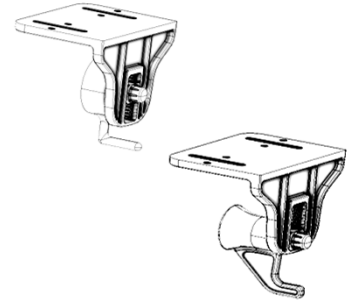

### Top Drop Clamps - Tube Arms

- |                          |       |                                  |        |
|--------------------------|-------|----------------------------------|--------|
| <input type="checkbox"/> | 31070 | E-Z Lock Clamps - Tube Arms Pair | \$ 208 |
|--------------------------|-------|----------------------------------|--------|

Below are adapter plates to allow Top Drop to work on Quantum TB3 Pads

- |                          |       |                             |       |
|--------------------------|-------|-----------------------------|-------|
| <input type="checkbox"/> | 31814 | Adapter Plates, 7.5" (Pair) | \$ 57 |
| <input type="checkbox"/> | 31797 | Adapter Plates 11.5"        | \$ 57 |

Tray Must be at least 3" wider than outside-to-outside armpad width

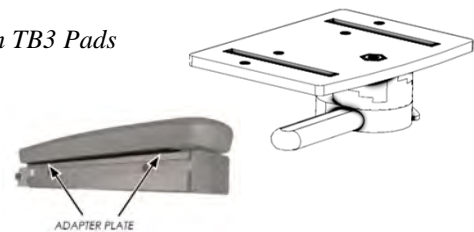

### Z Slide Brackets

- |                          |       |                                      |        |
|--------------------------|-------|--------------------------------------|--------|
| <input type="checkbox"/> | 32747 | 14" Long, 1 1/8" armpad thickness Pr | \$ 116 |
| <input type="checkbox"/> | 32799 | 9" Long, 1 1/8" armpad thickness Pr  | \$ 57  |
| <input type="checkbox"/> | 32793 | 9" Long, 1 1/4" armpad thickness Pr  | \$ 57  |
| <input type="checkbox"/> | 32800 | 9" Long, 1 1/2" armpad thickness Pr  | \$ 57  |

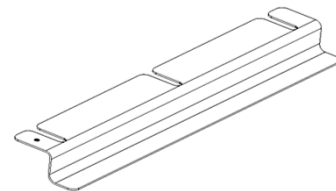

### U Slide Brackets

- |                          |       |                                     |        |
|--------------------------|-------|-------------------------------------|--------|
| <input type="checkbox"/> | 32798 | 6" Long, 1 1/8" armpad thickness Pr | \$ 106 |
| <input type="checkbox"/> | 32794 | 6" Long, 1 1/4" armpad thickness Pr | \$ 106 |
| <input type="checkbox"/> | 32797 | 6" Long, 1 1/2" armpad thickness Pr | \$ 106 |



### Tube Arm Brackets

- |                          |       |                                      |        |
|--------------------------|-------|--------------------------------------|--------|
| <input type="checkbox"/> | 31908 | 6" Long, 1 3/16" ring diameter Pr    | \$ 106 |
| <input type="checkbox"/> | 31907 | 7.5" Long, 1 3/16" ring diameter Pr  | \$ 106 |
| <input type="checkbox"/> | 31904 | 7.5" Long, 1 1/2" ring diameter Pr   | \$ 106 |
| <input type="checkbox"/> | 31902 | 7.5" Long, 1 11/16" ring diameter Pr | \$ 106 |

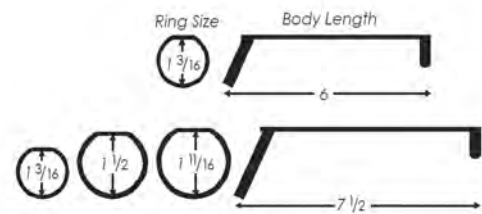
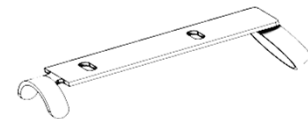

### Strap Mounting

- |                          |       |                            |       |
|--------------------------|-------|----------------------------|-------|
| <input type="checkbox"/> | 31091 | Hook and Loop Straps, Pair | \$ 19 |
| <input type="checkbox"/> | 31882 | Back Strap                 | \$ 25 |

## Special Instructions

Enter Any Special Instructions in the area below